

Specifications

DVM S Water

- Water Cooled, Variable Refrigerant Flow Heat Pump/ Heat Recovery Unit R410A.
- Suitable for indoor and outdoor installation
- Each unit houses one (8-12 hp) or two (20-30 hp) Inverter Scroll compressors with Flash Injection technology.



Model			AM080MXWANR/EU	AM100MXWANR/EU	AM120MXWANR/EU		
Power Supply			Φ, #, V, Hz	3Φ, 4, 380-415 V, 50/60 Hz	3Φ, 4, 380-415 V, 50/60 Hz	3Φ, 4, 380-415 V, 50/60 Hz	
Performance	hp		hp	8	10	12	
	Capacity (Nominal)	Cooling	kW	22.4	28.0	33.6	
		Heating	kW	25.2	31.5	37.8	
	Maximum number of connectable indoor units			ea	14	18	22
Total capacity of the connected indoor units	Min.		kW	11.2	14.0	16.8	
	Max.		kW	29.1	36.4	43.7	
Power	Power Input (Nominal)	Cooling	kW	3.67	4.87	6.00	
		Heating		3.97	5.04	6.25	
	Current Input (Nominal)	Cooling	A	5.9	8.1	9.6	
		Heating		6.4	8.4	10.0	
	Current	Minimum SSC value		MVA	3.9	3.9	4.8
MCA		A	16.1	16.1	20.0		
MFA		A	20	20	25		
COP ¹	Nominal Cooling		W/W	6.10	5.75	5.60	
	Nominal Heating		W/W	6.35	6.25	6.05	
Compressor	Type		-	Inverter Scroll	Inverter Scroll	Inverter Scroll	
	Output		kW × n	4.96 x 1	4.96 x 1	6.13 x 1	
	Oil	Type	-	PVE	PVE	PVE	
Initial Charge		cc	3,900	3,900	3,900		
Condenser	Type		Type	Plate Heat Exchanger	Plate Heat Exchanger	Plate Heat Exchanger	
	Pipe Size		ø, inch	PT1 1/4	PT1 1/4	PT1 1/4	
	Pressure Drop		kPa	22	30	43	
	Water Flow Rate		U/min	80	96	114	
	Max. Pressure		MPa	1.96	1.96	1.96	
	Liquid Pipe			ø, mm	9.52	9.52	12.70
				ø, inch	3/8	3/8	1/2
	Gas Pipe			ø, mm	19.05	22.22	28.58
		ø, inch	3/4	7/8	1 1/8		
Piping Connections	Discharge Gas Pipe		ø, mm	15.88	19.05	19.05	
			ø, inch	5/8	3/4	3/4	
	Piping length	Outdoor-Indoor	Max.	m	170 (190)	170 (190)	170 (190)
		After branch	Max.	m	90	90	90
	Total piping length	System	Actual	m	500	500	500
	Level difference	Outdoor-Indoor	Outdoor unit in highest position	m	50	50	50
			Indoor unit in highest position	m	40	40	40
Indoor-Indoor		Max.	m	50	50	50	
Wiring Connections	Communication	Minimum	mm ²	0.75	0.75	0.75	
	Remark		-	F1, F2	F1, F2	F1, F2	
Refrigerant	Type		-	R410A(Fluorinated greenhouse gas, GWP=2,088)			
	Factory Charging		kg	5.5	5.8	6.0	
Sound ²	Sound Pressure		Cooling		48	48	50
			Heating	dB(A)	51	51	52
	Sound Power			70	70	70	
External Dimensions	Net Weight		kg	160.0	160.0	160.0	
	Net Dimensions (W x H x D)		mm	770 x 1,000 x 545	770 x 1,000 x 545	770 x 1,000 x 545	
Operating Temperature Range	Cooling		°C	10.0-45.0	10.0-45.0	10.0-45.0	
	Heating		°C	10.0-45.0	10.0-45.0	10.0-45.0	



AM200MXWANR/EU	AM300KXWANR/EU
3Φ, 4, 380-415 V, 50/60 Hz	3Φ, 4, 380-415 V, 50/60 Hz
20	30
56.0	84
63	94.5
36	55
28.0	42.0
72.8	109.2
10.77	16.80
10.86	16.88
17.3	26.4
17.4	26.5
7.7	-
32.2	48.0
40	63
5.20	5.00
5.80	5.60
Inverter Scroll	SSC Scroll x 2
4.96 x 2	6.75 x 2
PVE	PVE
6,200	6,200
Plate Heat Exchanger	Plate Heat Exchanger
PT 1 1/4	PT 2
54	50
190	285
1.96	1.96
15.88	19.05
5/8	3/4
28.58	34.92
11/8	1 3/8
28.58	28.58
11/8	11/8
170 (190)	170 (190)
90	90
500	500
50	50
40	40
50	50
0.75	0.75
F1, F2	F1, F2
R410A(Fluorinated greenhouse gas, GWP=2,088)	
9.8	11.0
20.46	22.96
51	55
52	58
73	75
240.0	280.0
1,100 x 1,000 x 545	1,100 x 1,000 x 545
10.0-45.0	10.0-45.0
10.0-45.0	10.0-45.0

¹Performances are based on the following test conditions:

- Cooling: Indoor temperature: 27 °C DB, 19 °C WB, Inlet water temperature: 30 °C
- Heating: Indoor temperature: 20 °C DB, 15 °C WB, Inlet water temperature: 20 °C
- Equivalent refrigerant piping: 7.5 m, Level differences: 0 m

²Sound pressure level is obtained in an anechoic room. Sound pressure level is a relative value, depending on the distance and acoustic environment. Sound pressure level may differ according to operating conditions. Sound power level is an absolute value that a sound source generates.

Dimensional Drawing

DVM S Water

AM080/100/120MXWANR/EU

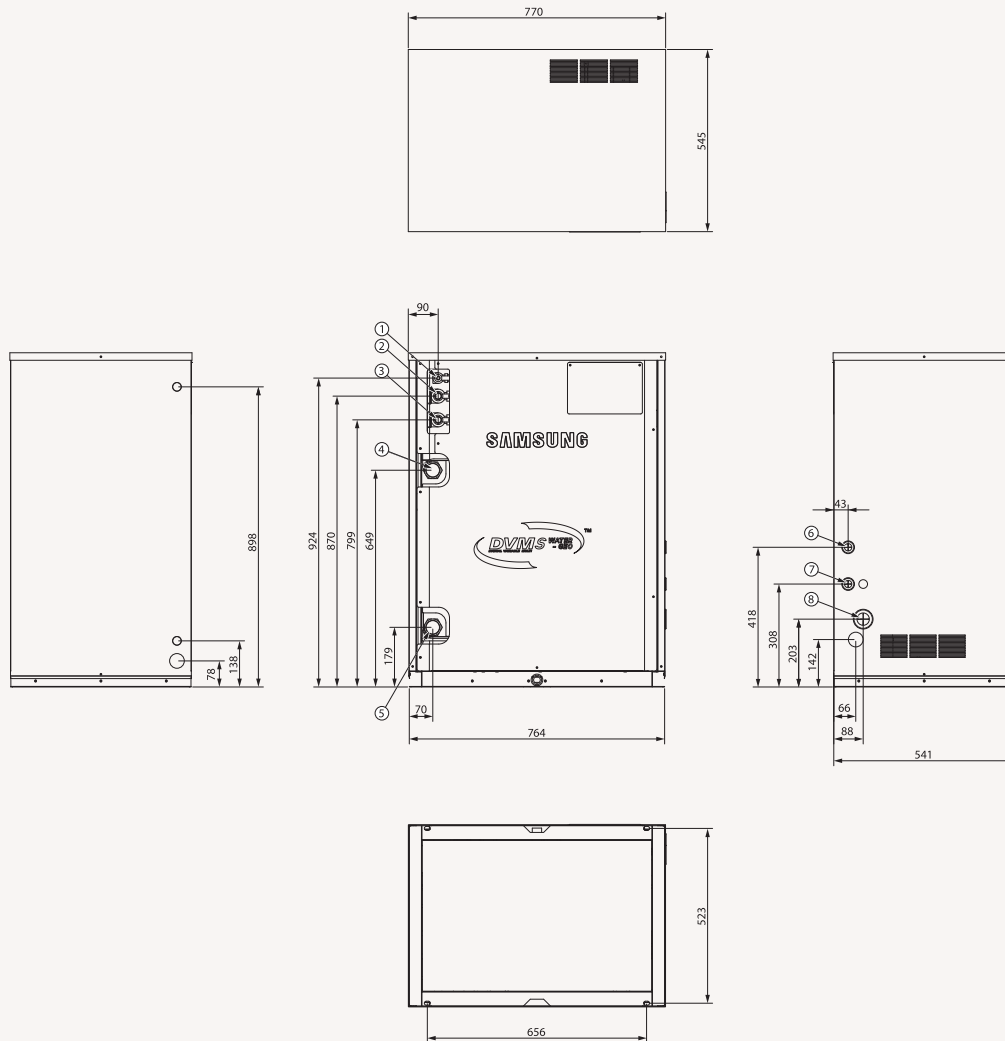

NO	Name	Description
1	Liquid Ref. pipe	ø19.05 (3/4)
2	High Pressure Gas Ref. pipe	ø28.58 (1 1/8)
3	Low Pressure Gas Ref. pipe	ø 34.92 (1 3/8)
4	Water outlet pipe	PT 2
5	Water inlet pipe	PT 2
6	Communication wiring conduits	
7	External contact wiring	
8	Power wiring conduits	

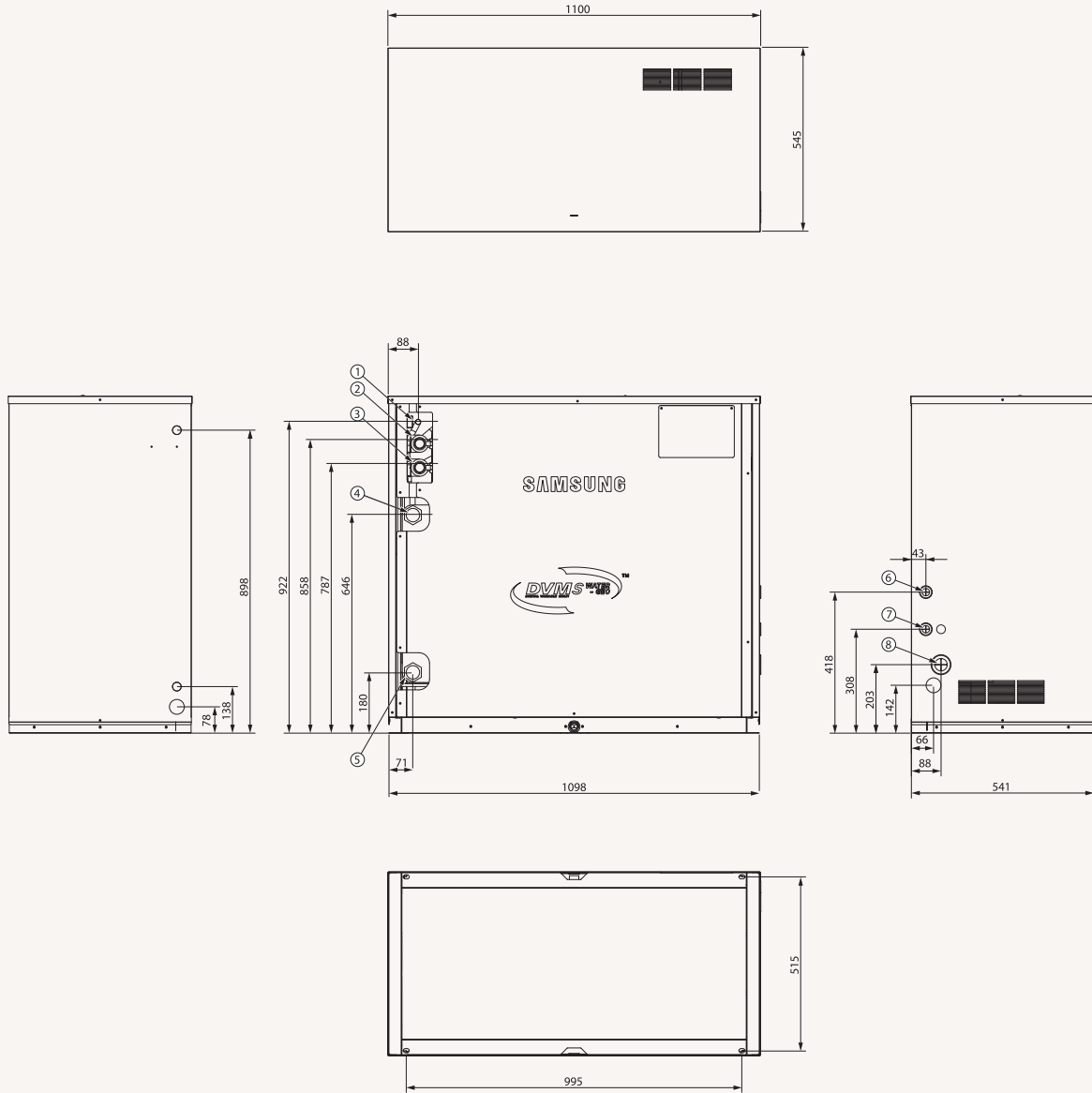

NO	Name	Description
1	Liquid Ref. pipe	15.88 (5/8)
2	High Pressure Gas Ref. pipe	ø28.58 (1 1/8)
3	Low Pressure Gas Ref. pipe	ø28.58 (1 1/8)
4	Water outlet pipe	PT 1 1/4
5	Water inlet pipe	PT 1 1/4
6	Communication wiring conduits	
7	External contact wiring	
8	Power wiring conduits	

Dimensional Drawing

DVM S Water

AM300MXWANR/EU

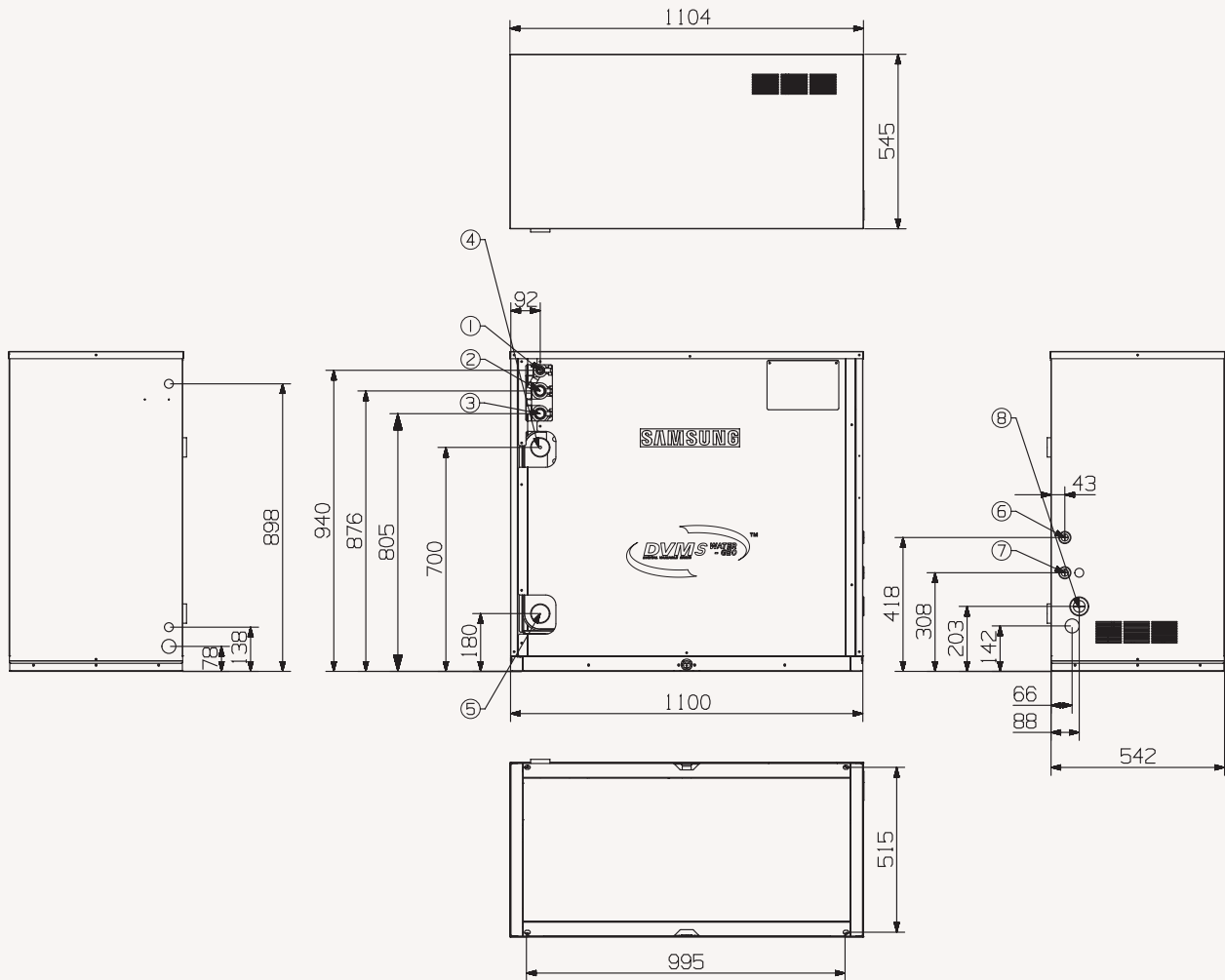

NO	Name	Description
1	Liquid Ref. pipe	ø19.05 (3/4)
2	High Pressure Gas Ref. pipe	ø28.58 (1 1/8)
3	Low Pressure Gas Ref. pipe	ø 34.92 (1 3/8)
4	Water outlet pipe	PT 2
5	Water inlet pipe	PT 2
6	Communication wiring conduits	
7	External contact wiring	
8	Power wiring conduits	

SAMSUNG

VRF

Technical Data Book

**DVM S Water for Europe
(R410A, 50/60Hz, HP/HR)**



Model : Premium energy efficiency Type
Premium compact type

History

Version	Modification	Date	Remark
Ver. 1.0	Release DVM S Water for Europe TDB	'17. 06. 23	
Ver. 1.01	Modify the Accessory Compatibility table for MCU kit(P67)	'17. 09. 13	
Ver. 1.1	Updated Sound Power data	'19. 05. 30	
Ver.1.2	Updated the Dimensional Drawing page	'21.02.15	

Nomenclature

Outdoor units

Model name

AM	080	M	X	W	A	N	R	/	EU
(1)	(2)	(3)	(4)	(5)	(6)	(7)	(8)		(Buyer)

(1) Classification

AM	DVM
----	-----

(5) Feature1

W	DVM WATER
---	-----------

(2) Capacity

x 1/10 HP (3 digits)

(6) Feature2

A	Standard + General Temp.+ Module
---	----------------------------------

(3) Version

F	2013
H	2014
J	2015
K	2016
M	2017

(7) Rating Voltage

N	3Ø, 380~415V, 50/60Hz
G	3Ø, 380~415V, 50Hz

(4) Product Type

X	Outdoor Unit
N	Indoor Unit

(8) Mode

R	Heat Recovery
H	Heat Pump

Features & Benefits

More efficient, more eco-friendly

The DVM S WATER air conditioning system saves money and the environment, while providing a powerful performance. Its innovative Dual Inverter Compressor with a high efficiency Vapor Injection System ensures powerful, rapid cooling and heating with minimum energy consumption, so it's very eco-friendly. A Plate Heat Exchanger also improves the heat exchange efficiency and ensures stable cooling and heating performances.

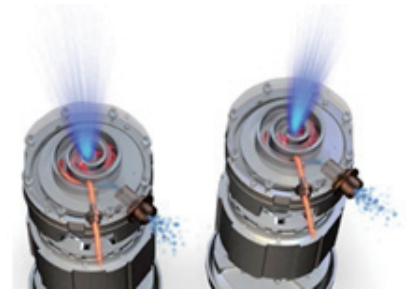

Flexible installation almost anywhere

The DVM S WATER air conditioning system can be installed almost anywhere, regardless of its location or distance from the building. It has a maximum piping length of up to 170 meters (558 feet) between the outdoor and indoor units, while still ensuring complete reliability. It can also reach up to a height of 50 meters (164 feet), which is the equivalent of 10 stories.



Lower installation costs, great capacity

The DVM S WATER air conditioning system is much more economical to install as it has a small footprint and lightweight design, but a large 30 horsepower (HP) capacity. So instead of installing two 10HP units you only need one 30HP Samsung unit – using 56% less space and significantly reducing the costs of valves, fittings and gauges. You can also combine up to three units to create a total capacity of 90HP.

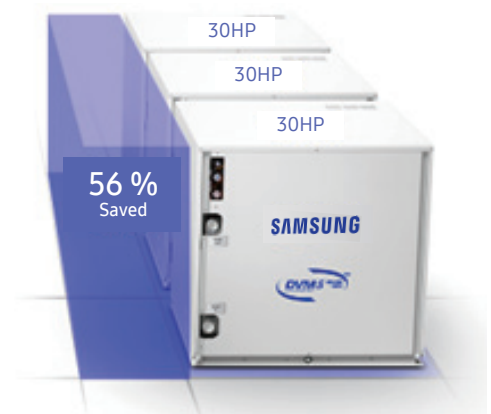

Independently cool and heat

With the DVM S WATER air conditioning system's optional Mode Control Unit (MCU) you can independently cool and heat different spaces at the same time. Instead of just heating or cooling all spaces at the same time, with the MCU each indoor unit can be operated separately, so you can simultaneously heat some rooms or areas of the building, while cooling others.

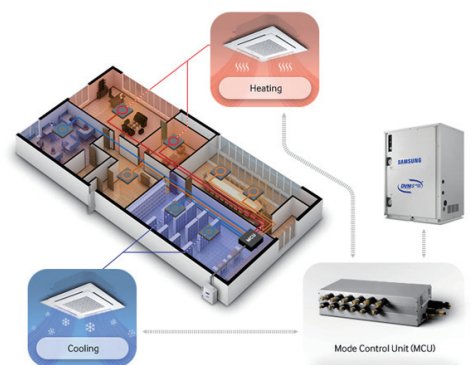

Contents

1. Line-up	6
2. Specification	10
3. Electric Characteristics	21
4. Dimensional Drawing	23
5. Center of Gravity	26
6. Electrical Wiring Diagram	28
7. Sound Level	30
8. Operating Range	34
9. Piping Diagram	37
10. Installation	40
11. Accessory	60

1. Line-up

1) Outdoor units combination Table

Premium energy efficiency type

System Model			Capacity (HP)			
Capa.(HP)	Model	No. of Modules	8	10	12	20
8	AM080MXWANR	1	1			
10	AM100MXWANR	1		1		
12	AM120MXWANR	1			1	
16	AM160MXWANR2	2	2			
18	AM180MXWANR2	2	1	1		
20	AM200MXWANR	1				1
22	AM220MXWANR2	2		1	1	
24	AM240MXWANR2	2			2	
26	AM260MXWANR2	3	2	1		
28	AM280MXWANR2	2	1			1
30	AM300MXWANR2	2		1		1
32	AM320MXWANR2	2			1	1
34	AM340MXWANR2	3		1	2	
36	AM360MXWANR2	3	2			1
38	AM380MXWANR2	3	1	1		1
40	AM400MXWANR2	2				2
42	AM420MXWANR2	3		1	1	1
44	AM440MXWANR2	3			2	1
48	AM480MXWANR2	3	1			2
50	AM500MXWANR2	3		1		2
52	AM520MXWANR2	3			1	2
60	AM600MXWANR2	3				3

1. Line-up

1) Outdoor units combination Table





Premium compact type

Capa.(HP)	System Model		Capacity (HP)				
	Model	No. of Modules	8	10	12	20	30
30	AM300KXWANR	1					1
38	AM380MXWANR1	2	1				1
40	AM400MXWANR1	2		1			1
42	AM420MXWANR1	2			1		1
46	AM460MXWANR1	3	2				1
48	AM480MXWANR1	3	1	1			1
50	AM500MXWANR1	2				1	1
52	AM520MXWANR1	3		1	1		1
54	AM540MXWANR1	3			2		1
58	AM580MXWANR1	3	1			1	1
60	AM600MXWANR1	2					2
62	AM620MXWANR1	3			1	1	1
68	AM680MXWANR1	3	1				2
70	AM700MXWANR1	3		1			2
80	AM800MXWANR1	3				1	2
90	AM900MXWANR1	3					3

NOTE





















































- Make sure to use an indoor unit that is compatible with DVM S WATER-GEO.
- Indoor units can be connected within the range indicated in following table.
- If the total capacity of the connected indoor units exceeds the indicated maximum capacity, cooling and heating capacity of the indoor unit may decrease.
- Total capacity of the connected indoor units can be allowed from 50% to 130% of the total outdoor unit capacity. $0.5 \times \Sigma(\text{Outdoor unit capacity}) \leq \text{Total capacity of the connected indoor units} \leq 1.3 \times \Sigma(\text{Outdoor unit capacity})$
- You can connect maximum 64 indoor units to the outdoor unit. Maximum quantity of connectable indoor unit is set to 64 since outdoor unit only support up to 64 communication address. Indoor unit address can be assigned from 0~63. If the indoor unit address was assigned from 64~79, E201 error will occur.
- Minimum capacity of the indoor unit is 1.7 kW.
- Installation combination must be complied when composing outdoor unit combination.
- Sum of total amount of additional refrigerant and the basic amount of refrigerant should not exceed 100kg (220lb). If the refrigerant exceeds 100kg (220lb), separate the module so that the weight of the refrigerant doesn't exceed 100kg.

2) External appearance (outdoor unit)

Capacity (HP)	8	10	12	20	30
Type	HR / HP				
Model					

























1. Line-up

3) Indoor units

Model	Capacity (kW)								
	1.7	2.2	2.8	3.6	4.5	5.6	6.0	7.1	9.0
Slim 1way cassette (JSF)									
2way cassette									
Global 4way cassette									
4way CST (600 X 600)									
360 CST									
Floor Standing Unit									
Slim duct									
MSP duct									
HSP duct									
Ceiling									
Console									
Neo forte									
Neo forte (with EEV)									
Hydro unit / HE									
Hydro unit / HT									
ERV plus									

1. Line-up

3) Indoor units

Model	Capacity (kW)							
	11.2	12.8	14.0	22.0	28.0	44.8	500CMH	1000CMH
Slim 1way cassette(JSF)								
2way cassette								
Global 4way cassette								
4way CST (600 X 600)								
360 CST								
Floor Standing Unit								
Slim duct								
MSP duct								
HSP duct								
Ceiling								
Console								
Neo forte								
Neo forte (with EEV)								
Hydro unit / HE								
Hydro unit / HT								
ERV plus								

2. Specification

Premium energy efficiency Type

Type				DVM S Water	DVM S Water	DVM S Water	DVM S Water	
Model Name	Outdoor unit module 1			AM080MXWA**	AM100MXWA**	AM120MXWA**	AM160MXWA**	
	Outdoor unit module 2			AM080MXWA**	AM100MXWA**	AM120MXWA**	AM080MXWA**	
	Outdoor unit module 3			-	-	-	-	
	Outdoor unit module 4			-	-	-	-	
Power Supply				∅, #, V, Hz	3,4,380-415,50/60	3,4,380-415,50/60	3,4,380-415,50/60	
Mode				-	HEAT RECOVERY	HEAT RECOVERY	HEAT RECOVERY	
Performance	HP	HP		8	10	12	16	
		Ton		6.37	7.96	9.55	12.74	
	Capacity	Cooling	kW		22.4	28.0	33.6	44.8
			Btu/h		76,400	95,500	114,600	152,900
		Heating 2 ¹	kW		25.2	31.5	37.8	50.4
			Btu/h		86,000	107,500	129,000	172,000
		Heating 4 ¹	kW		21.6	25.8	31.1	-
			Btu/h		73,700	88,000	106,500	-
Maximum number of connectable indoor units	ea		14	18	22	29		
	Total capacity of the connected Indoor Units	Min.	kW	11.2	14.0	16.8	22.4	
Max.		kW	29.1	36.4	43.7	58.2		
Power	Power Input	Cooling 1 ¹	kW	3.67	4.87	6	7.34	
		Heating 2 ¹	kW	3.97	5.04	6.25	7.94	
		Heating 4 ¹	kW	4.45	5.43	6.76	-	
	Current Input	Cooling 1 ¹	A	5.9	7.8	9.6	12.4	
		Heating 2 ¹	A	6.4	8.1	10.0	13.2	
	Current	Minimum Ssc value		MVA	3.9	3.9	4.8	7.8
		MCA		A	16.1	16.1	20.0	31.8
		MFA		A	20.0	20.0	25.0	40.0
COP	Cooling 1 ¹		W/W	6.10	5.75	5.60	6.10	
	Heating 2 ¹		W/W	6.35	6.25	6.05	6.35	
	Heating 4 ¹		W/W	4.85	4.75	4.6	-	
Casing	Material	Cabinet	-	Steel plate	Steel plate	Steel plate	Steel plate	
		Base	-	Steel plate	Steel plate	Steel plate	Steel plate	
Compressor	Type	-		Inverter Scroll	Inverter Scroll	Inverter Scroll	Inverter Scroll	
	Output	kW × n		(5.18) x 1	(5.18) x 1	(6.39) x 1	(5.18) x 2	
	Model Name	-		DS-GB052FAVB x 1	DS-GB052FAVB x 1	DS-GB052FAVB x 1	DS-GB052FAVB x 2	
	Oil	Type	-		PVE	PVE	PVE	PVE
Initial Charge		cc		1,100	1,100	1,100	1100 x 2	
Condenser	Type	Type		PHE(Plate Heat Exchanger)	PHE(Plate Heat Exchanger)	PHE(Plate Heat Exchanger)	PHE(Plate Heat Exchanger)	
	Pipe Size	∅, inch		PT1-1/4	PT1-1/4	PT1-1/4	PT1-1/4 x 2	
	Pressure Drop	kPa		22.0	30.0	43.0	22.0 x 2	
	Water Flow Rate	LPM		80.0	96.0	114.0	80.0 x 2	
	Max. Pressure	Mpa		1.96	1.96	1.96	1.96	
Piping Connections	Liquid Pipe	Type		Brazed connection	Brazed connection	Brazed connection	Brazed connection	
		∅, mm		9.52	9.52	12.7	12.7	
		∅, inch		3/8"	3/8"	1/2"	1/2"	
	Gas Pipe (Low pressure gas ref. pipe)	Type		Brazed connection	Brazed connection	Brazed connection	Brazed connection	
		∅, mm		19.05	22.22	28.58	28.58	
		∅, inch		3/4"	7/8"	1 1/8"	1 1/8"	
	Discharge Pipe (High pressure gas ref. pipe)	Type		Brazed connection	Brazed connection	Brazed connection	Brazed connection	
		∅, mm		15.88	19.05	19.05	22.22	
		∅, inch		5/8"	3/4"	3/4"	7/8"	
	Heat insulation				-	Both liquid and gas pipes	Both liquid and gas pipes	Both liquid and gas pipes
	Piping length	ODU-IDU	Max.	m	170 (190)	170 (190)	170 (190)	170 (190)
			After branch	Max.	m	90	90	90
Total piping length		System	Actual	m	500	500	500	
Level difference	ODU-IDU	Outdoor unit in highest position		m	50	50	50	
		Indoor unit in highest position		m	40	40	40	
Wiring connections	Communication	IDU-IDU		Max.	m	50	50	
		Minimum		mm ²	0.75	0.75	0.75	
		Remark		-	F1, F2	F1, F2	F1, F2	
Refrigerant	Type			-	R410A	R410A	R410A	
	Factory Charging			kg	5.5	5.8	6.0	
Sound ³¹	Sound Pressure	Cooling		45	47	47	49	
		Heating		46	49	50	50	
	Sound Power		dB(A)		70	70	70	73
External Dimension	Net Weight			kg	160	160	160 x 2	
	Shipping Weight			kg	167	167	167 x 2	
	Net Dimensions (WxHxD)			mm	770 x 1,000 x 545	770 x 1,000 x 545	770 x 1,000 x 545	
	Shipping Dimensions (WxHxD)			mm	840 x 1,200 x 620	840 x 1,200 x 620	840 x 1,200 x 620	
Operating Temp. Range	Cooling			°C	10.0 - 45.0	10.0 - 45.0	10.0 - 45.0	
	Heating			°C	10.0 - 45.0	10.0 - 45.0	10.0 - 45.0	

2. Specification

Premium energy efficiency Type

Type			DVM S Water	DVM S Water	DVM S Water	DVM S Water	
Model Name	Outdoor unit module 1		AM180MXWA**	AM200MXWA**	AM220MXWA**	AM240MXWA**	
	Outdoor unit module 2		AM080MXWA**	AM200MXWA**	AM100MXWA**	AM120MXWA**	
	Outdoor unit module 3		AM100MXWA**	-	AM120MXWA**	AM120MXWA**	
	Outdoor unit module 4		-	-	-	-	
Power Supply	Ø, #, V, Hz		3,4,380-415,50/60	3,4,380-415,50/60	3,4,380-415,50/60	3,4,380-415,50/60	
Mode			HEAT RECOVERY	HEAT RECOVERY	HEAT RECOVERY	HEAT RECOVERY	
Performance	HP	HP	18	20	22	24	
	Ton	Ton	14.33	15.92	17.52	19.11	
	Capacity	Cooling	kW	50.4	56.0	61.6	67.2
			Btu/h	172,000	191,100	210,200	229,300
			kW	56.7	63.0	69.3	75.6
		Heating 2**	Btu/h	193,500	215,000	236,500.0	258,000
			kW	-	50.4	-	-
Btu/h			-	172,000	-	-	
Maximum number of connectable indoor units	ea		32	36	40	44	
	Total capacity of the connected Indoor Units	Min.	kW	25.2	28.0	30.8	33.6
Max.		kW	65.5	72.8	80.1	87.4	
Power	Power Input	Cooling 1**	kW	8.54	10.77	10.87	12
		Heating 2**	kW	9.01	10.86	11.29	12.5
		Heating 4**	kW	-	-	-	-
	Current Input	Cooling 1**	A	14.3	17.3	18.4	20.6
		Heating 2**	A	15.0	17.4	18.8	20.8
	Current	Minimum Ssc value	MVA	7.8	7.7	8.7	9.6
		MCA	A	32.2	31.8	36.1	40.0
MFA		A	40.0	40.0	40.0	50.0	
COP	Cooling 1**	W/W	5.90	5.20	5.67	5.60	
	Heating 2**	W/W	6.29	5.80	6.14	6.05	
	Heating 4**	W/W	-	4.30	-	-	
Casing	Material	Cabinet	-	Steel plate	Steel plate	Steel plate	
		Base	-	Steel plate	Steel plate	Steel plate	
Compressor	Type		-	Inverter Scroll	Inverter Scroll	Inverter Scroll	
	Output		kW x n	(5.18) x 2	(5.18) x 2	(5.18) x 1 + (6.39) x 1	
	Model Name		-	DS-GB052FAVB x 2	DS-GB052FAVB x 2	DS-GB052FAVB x 1 + DS-GB066FAVB X 1	
	Oil	Type	-	PVE	PVE	PVE	
	Initial Charge		cc	1,100 x 2	1,100 x 2	1,100 x 2	
Condenser	Type	Type	PHE(Plate Heat Exchanger)	PHE(Plate Heat Exchanger)	PHE(Plate Heat Exchanger)	PHE(Plate Heat Exchanger)	
	Pipe Size	Ø, inch	PT 1-1/4 x 2	PT 1-1/4	PT 1-1/4 x 2	PT 1-1/4 x 2	
	Pressure Drop	kPa	22.0 + 30.0	54.0	30.0 + 43.0	43.0 x 2	
	Water Flow Rate	LPM	80.0 + 96.0	190.0	96.0 + 114.0	114.0 x 2	
	Max. Pressure	Mpa	1.96	1.96	1.96	1.96	
Piping Connections	Liquid Pipe	Type	Brazed connection	Brazed connection	Brazed connection	Brazed connection	
		Ø, mm	15.88	15.88	15.88	15.88	
		Ø, inch	5/8"	5/8"	5/8"	5/8"	
	Gas Pipe (Low pressure gas ref. pipe)	Type	Brazed connection	Brazed connection	Brazed connection	Brazed connection	
		Ø, mm	28.58	28.58	28.58	28.58	
		Ø, inch	1 1/8"	1 1/8"	1 1/8"	1 1/8"	
	Discharge Pipe (High pressure gas ref. pipe)	Type	Brazed connection	Brazed connection	Brazed connection	Brazed connection	
		Ø, mm	22.22	28.58	28.58	28.58	
		Ø, inch	7/8"	1 1/8"	1 1/8"	1 1/8"	
	Heat insulation		-	Both liquid and gas pipes	Both liquid and gas pipes	Both liquid and gas pipes	
Piping length	ODU-IDU	Max.	m	170 (190)	170 (190)	170 (190)	
	After branch	Max.	m	90	90	90	
Total piping length	System	Actual	m	500	500	500	
Level difference	ODU-IDU	Outdoor unit in highest position	m	50	50	50	
		Indoor unit in highest position	m	40	40	40	
	IDU-IDU	Max.	m	50	50	50	
Wiring connections	Communication	Minimum	mm ²	0.75	0.75	0.75	
	Remark		-	F1, F2	F1, F2	F1, F2	
Refrigerant	Type		-	R410A	R410A	R410A	
	Factory Charging		kg	11.3	9.8	11.8	
Sound ³⁾	Sound Pressure	Cooling	dB(A)	50	51	51	
		Heating	dB(A)	51	52	53	
	Sound Power		W	73	73	73	
External Dimension	Net Weight		kg	160 x 2	240	160 x 2	
	Shipping Weight		kg	167 x 2	250	167 x 2	
	Net Dimensions (WxHxD)		mm	(770 x 1,000 x 545) x 2	1,100 x 1,000 x 545	(770 x 1,000 x 545) x 2	
	Shipping Dimensions (WxHxD)		mm	(840 x 1,200 x 620) x 2	1,170 x 1,200 x 620	(840 x 1,200 x 620) x 2	
Operating Temp. Range	Cooling		°C	10.0 ~ 45.0	10.0 ~ 45.0	10.0 ~ 45.0	
	Heating		°C	10.0 ~ 45.0	10.0 ~ 45.0	10.0 ~ 45.0	

2. Specification

Premium energy efficiency Type

Type			DVM S Water	DVM S Water	DVM S Water	DVM S Water	
Model Name	Outdoor unit module 1		AM260MXWA**	AM280MXWA**	AM300MXWA**	AM320MXWA**	
	Outdoor unit module 2		AM080MXWA**	AM080MXWA**	AM100MXWA**	AM120MXWA**	
	Outdoor unit module 3		AM080MXWA**	AM200MXWA**	AM200MXWA**	AM200MXWA**	
	Outdoor unit module 4		AM100MXWA**	-	-	-	
Power Supply			Ø, #, V, Hz	3,4,380-415,50/60	3,4,380-415,50/60	3,4,380-415,50/60	
Mode			-	HEAT RECOVERY	HEAT RECOVERY	HEAT RECOVERY	
Performance	HP	HP	26	28	30	32	
	Ton	Ton	20.70	22.29	23.88	25.48	
	Capacity	Cooling	kW	72.8	78.4	84.0	89.6
			Btu/h	248,400	267,500	286,600	305,700
		Heating ²⁾	kW	81.9	88.2	94.5	100.8
			Btu/h	279,500	301,000	322,400	343,900
	Heating ⁴⁾	kW	-	-	-	-	
		Btu/h	-	-	-	-	
Maximum number of connectable indoor units	Total capacity of the connected Indoor Units		ea	47	51	55	
	Min.	kW	36.4	39.2	42.0	44.8	
Power	Power Input	Max.	kW	94.6	101.9	109.2	
		Cooling ¹⁾	kW	12.21	14.44	15.64	
		Heating ²⁾	kW	12.98	14.83	15.9	
	Current Input	Heating ⁴⁾	kW	-	-	-	
		Cooling ¹⁾	A	20.5	23.5	25.4	
	Current	Heating ²⁾	A	21.6	24.0	25.8	
		Minimum Ssc value	MVA	11.7	11.6	11.6	
		MCA	A	48.3	47.9	47.9	
MFA		A	63.0	63.0	63.0		
COP	Cooling ¹⁾		W/W	5.96	5.43	5.37	
	Heating ²⁾		W/W	6.31	5.95	5.94	
	Heating ⁴⁾		W/W	-	-	-	
Casing	Material	Cabinet	-	Steel plate	Steel plate	Steel plate	
		Base	-	Steel plate	Steel plate	Steel plate	
Compressor	Type	-	Inverter Scroll	Inverter Scroll	Inverter Scroll	Inverter Scroll	
	Output	kW x n	(5.18) x 3	(5.18) x 3	(5.18) x 3	(5.18) x 2 + (6.39) x 1	
	Model Name	-	DS-GB052FAVB x 3	DS-GB052FAVB x 3	DS-GB052FAVB x 3	DS-GB066FAVB x 1 + DS-GB052FAVB x 2	
	Oil	Type	-	PVE	PVE	PVE	
	Initial Charge	cc	1,100 x 3	1,100 + (1,100 x 2)	1,100 + (1,100 x 2)	1,100 + (1,100 x 2)	
Condenser	Type	Type	PHE(Plate Heat Exchanger)	PHE(Plate Heat Exchanger)	PHE(Plate Heat Exchanger)	PHE(Plate Heat Exchanger)	
	Pipe Size	Ø, inch	PT1-1/4 x 3	PT1-1/4 x 2	PT1-1/4 x 2	PT1-1/4 x 2	
	Pressure Drop	kPa	22.0 x 2 + 30.0	22.0 + 54.0	30.0 + 54.0	43.0 + 54.0	
	Water Flow Rate	LPM	80.0 x 2 + 96.0	80.0 + 190.0	96.0 + 190.0	114.0 + 190.0	
	Max. Pressure	Mpa	1.96	1.96	1.96	1.96	
Piping Connections	Liquid Pipe	Type	Brazed connection	Brazed connection	Brazed connection	Brazed connection	
		Ø, mm	19.05	19.05	19.05	19.05	
		Ø, inch	3/4"	3/4"	3/4"	3/4"	
	Gas Pipe (Low pressure gas ref. pipe)	Type	Brazed connection	Brazed connection	Brazed connection	Brazed connection	
		Ø, mm	34.92	34.92	34.92	34.92	
		Ø, inch	1 3/8"	1 3/8"	1 3/8"	1 3/8"	
	Discharge Pipe (High pressure gas ref. pipe)	Type	Brazed connection	Brazed connection	Brazed connection	Brazed connection	
		Ø, mm	28.58	28.58	28.58	28.58	
		Ø, inch	1 1/8"	1 1/8"	1 1/8"	1 1/8"	
	Heat insulation		-	Both liquid and gas pipes	Both liquid and gas pipes	Both liquid and gas pipes	Both liquid and gas pipes
	Piping length	ODU-IDU	Max.	m	170 (190)	170 (190)	170 (190)
		After branch	Max.	m	90	90	90
Total piping length	System	Actual	m	500	500	500	
Level difference	ODU-IDU	Outdoor unit in highest position	m	50	50	50	
		Indoor unit in highest position	m	40	40	40	
	IDU-IDU	Max.	m	50	50	50	
Wiring connections	Communication	Minimum	mm ²	0.75	0.75	0.75	
		Remark	-	F1, F2	F1, F2	F1, F2	
Refrigerant	Type	-	R410A	R410A	R410A	R410A	
	Factory Charging	kg	16.8	15.3	15.6	15.8	
Sound ³⁾	Sound Pressure	Cooling	dB(A)	51	52	52	
		Heating	dB(A)	53	53	54	
	Sound Power	dB(A)	75	75	75		
External Dimension	Net Weight	kg	160 x 3	160 + 240	160 + 240	160 + 240	
	Shipping Weight	kg	167 x 3	167 + 250	167 + 250	167 + 250	
	Net Dimensions (WxHxD)	mm	(770 x 1,000 x 545) x 3	770 x 1,000 x 545 + 1,100 x 1,000 x 545	770 x 1,000 x 545 + 1,100 x 1,000 x 545	770 x 1,000 x 545 + 1,100 x 1,000 x 545	
	Shipping Dimensions (WxHxD)	mm	(840 x 1,200 x 620) x 3	840 x 1,200 x 620 + 1,170 x 1,200 x 620	840 x 1,200 x 620 + 1,170 x 1,200 x 620	840 x 1,200 x 620 + 1,170 x 1,200 x 620	
Operating Temp. Range	Cooling	°C	10.0 - 45.0	10.0 - 45.0	10.0 - 45.0	10.0 - 45.0	
	Heating	°C	10.0 - 45.0	10.0 - 45.0	10.0 - 45.0	10.0 - 45.0	

2. Specification

Premium energy efficiency Type

Type			DVM S Water	DVM S Water	DVM S Water	DVM S Water	
Model Name	Outdoor unit module 1		AM340MXWA**	AM360MXWA**	AM380MXWA**	AM400MXWA**	
	Outdoor unit module 2		AM100MXWA**	AM080MXWA**	AM080MXWA**	AM200MXWA**	
	Outdoor unit module 3		AM120MXWA**	AM080MXWA**	AM100MXWA**	AM200MXWA**	
	Outdoor unit module 4		AM120MXWA**	AM200MXWA**	AM200MXWA**	-	
Power Supply			Ø, #, V, Hz	3,4,380-415,50/60	3,4,380-415,50/60	3,4,380-415,50/60	
Mode			-	HEAT RECOVERY	HEAT RECOVERY	HEAT RECOVERY	
Performance	HP		HP	34	36	38	40
	Ton		Ton	27.07	28.66	30.26	31.85
	Capacity	Cooling	kW	95.2	100.8	106.4	112.0
			Btu/h	324,800	343,900	363,100	382,200
		Heating 2**	kW	107.1	113.4	119.7	126.0
			Btu/h	365,400	386,900	408,400	429,900
	Heating 4**	kW	-	-	-	-	
		Btu/h	-	-	-	-	
Maximum number of connectable indoor units	Total capacity of the connected Indoor Units		ea	62	64	64	64
	Min.	kW	47.6	50.4	53.2	56.0	
Max.		kW	123.8	131.0	138.3	145.6	
	Power	Power Input	Cooling 1**	kW	16.87	18.11	19.31
Heating 2**			kW	17.54	18.80	19.87	21.72
Heating 4**			kW	-	-	-	-
Current Input		Cooling 1**	A	28.7	29.7	31.6	34.6
		Heating 2**	A	29.2	30.6	32.4	34.6
Current		Minimum Ssc value	MVA	13.5	15.5	15.5	15.4
		MCA	A	56.1	64.0	64.0	63.6
		MFA	A	63.0	75.0	75.0	75.0
COP	Cooling 1**		W/W	5.64	5.57	5.51	5.20
	Heating 2**		W/W	6.11	6.03	6.02	5.80
	Heating 4**		W/W	-	-	-	-
Casing	Material	Cabinet	-	Steel plate	Steel plate	Steel plate	Steel plate
		Base	-	Steel plate	Steel plate	Steel plate	Steel plate
Compressor	Type		-	Inverter Scroll	Inverter Scroll	Inverter Scroll	Inverter Scroll
	Output		kW x n	(5.18) x 1 + (6.39) x 2	(5.18) x 4	(5.18) x 4	(5.18) x 4
	Model Name		-	"DS-GB052FAVB x 1 + DS-GB066FAVB x 2"	DS-GB052FAVB x 4	DS-GB052FAVB x 4	DS-GB052FAVB x 4
	Oil	Type	-	PVE	PVE	PVE	PVE
Initial Charge		cc	1,100 x 3	(1,100 x 2)+(1,100 x 2)	(1,100 x 2)+(1,100 x 2)	(1,100 x 2)+(1,100 x 2)	
Condenser	Type		Type	PHE(Plate Heat Exchanger)	PHE(Plate Heat Exchanger)	PHE(Plate Heat Exchanger)	PHE(Plate Heat Exchanger)
	Pipe Size		Ø, inch	PT 1-1/4 x 3	PT 1-1/4 x 3	PT 1-1/4 x 3	PT 1-1/4 x 2
	Pressure Drop		kPa	30.0 + 43.0 x 2	22.0 x 2 + 54.0	22.0 + 30.0 + 54.0	54.0 x 2
	Water Flow Rate		LPM	96.0 + 114.0 x 2	80.0 x 2 + 190.0	80.0 + 96.0 + 190.0	190.0 x 2
	Max. Pressure		Mpa	1.96	1.96	1.96	1.96
Piping Connections	Liquid Pipe		Type	Brazed connection	Brazed connection	Brazed connection	Brazed connection
			Ø, mm	19.05	19.05	19.05	19.05
			Ø, inch	3/4"	3/4"	3/4"	3/4"
	Gas Pipe		Type	Brazed connection	Brazed connection	Brazed connection	Brazed connection
	(Low pressure gas ref. pipe)		Ø, mm	34.92	41.28	41.28	41.28
			Ø, inch	1 3/8"	1 5/8"	1 5/8"	1 5/8"
	Discharge Pipe		Type	Brazed connection	Brazed connection	Brazed connection	Brazed connection
	(High pressure gas ref. pipe)		Ø, mm	28.58	34.92	34.92	34.92
			Ø, inch	1 1/8"	1 3/8"	1 3/8"	1 3/8"
	Heat insulation		-	Both liquid and gas pipes	Both liquid and gas pipes	Both liquid and gas pipes	Both liquid and gas pipes
Piping length	ODU-IDU	Max.	m	170 (190)	170 (190)	170 (190)	170 (190)
		After branch	m	90	90	90	90
	System		Actual	m	500	500	500
	Total piping length			m	500	500	500
Level difference	ODU-IDU	Outdoor unit in highest position	m	50	50	50	50
		Indoor unit in highest position	m	40	40	40	40
	IDU-IDU	Max.	m	50	50	50	50
Wiring connections	Communication	Minimum	mm ²	0.75	0.75	0.75	0.75
		Remark	-	F1, F2	F1, F2	F1, F2	F1, F2
Refrigerant	Type		-	R410A	R410A	R410A	R410A
	Factory Charging		kg	17.8	20.8	21.1	19.6
Sound ³⁾	Sound Pressure	Cooling	dB(A)	52	53	53	54
		Heating	dB(A)	55	54	55	56
	Sound Power			dB(A)	75	76	76
External Dimension	Net Weight		kg	160 x 3	160 x 2 + 240	160 x 2 + 240	240 x 2
	Shipping Weight		kg	167 x 3	167 x 2 + 250	167 x 2 + 250	250 x 2
	Net Dimensions (WxHxD)		mm	(770 x 1,000 x 545) x 3	(770 x 1,000 x 545) x 2 + 1,100 x 1,000 x 545	(770 x 1,000 x 545) x 2 + 1,100 x 1,000 x 545	(1,100 x 1,000 x 545) x 2
	Shipping Dimensions (WxHxD)		mm	(840 x 1,200 x 620) x 3	(840 x 1,200 x 620) x 2 + 1,170 x 1,200 x 620	(840 x 1,200 x 620) x 2 + 1,170 x 1,200 x 620	(1,170 x 1,200 x 620) x 2
Operating Temp. Range	Cooling		°C	10.0 ~ 45.0	10.0 ~ 45.0	10.0 ~ 45.0	10.0 ~ 45.0
	Heating		°C	10.0 ~ 45.0	10.0 ~ 45.0	10.0 ~ 45.0	10.0 ~ 45.0

2. Specification

Premium energy efficiency Type

Type			DVM S Water	DVM S Water	DVM S Water	
Model Name	Outdoor unit module 1		AM420MXWA**	AM440MXWA**	AM480MXWA**	
	Outdoor unit module 2		AM100MXWA**	AM120MXWA**	AM080MXWA**	
	Outdoor unit module 3		AM120MXWA**	AM120MXWA**	AM200MXWA**	
	Outdoor unit module 4		AM200MXWA**	AM200MXWA**	AM200MXWA**	
Power Supply			Ø, #, V, Hz	3,4,380-415,50/60	3,4,380-415,50/60	
Mode			-	HEAT RECOVERY	HEAT RECOVERY	
Performance	HP	HP	42	44	48	
	Ton	Ton	33.44	35.03	38.22	
	Capacity	Cooling	kW	117.6	123.2	134.4
			Btu/h	401,300	420,400	458,600
			kW	132.3	138.6	151.2
		Heating 2 ^o	Btu/h	451,400	472,900	515,900
			kW	-	-	-
Btu/h			-	-	-	
Maximum number of connectable indoor units	Total capacity of the connected Indoor Units	Min.	kW	58.8	61.6	
		Max.	kW	152.9	160.2	
	Power Input	Cooling 3 ^o	kW	19.31	22.77	
		Heating 2 ^o	kW	19.87	23.36	
Heating 4 ^o		kW	-	-		
Current Input	Cooling 3 ^o	A	35.7	37.9		
	Heating 2 ^o	A	36.2	38.2		
Current	Minimum Ssc value	MVA	16.4	17.3		
	MCA	A	67.9	71.8		
	MFA	A	75.0	80.0		
COP	Cooling 3 ^o	W/W	6.09	5.41		
	Heating 2 ^o	W/W	6.66	5.93		
	Heating 4 ^o	W/W	-	-		
Casing	Material	Cabinet	-	Steel plate	Steel plate	
		Base	-	Steel plate	Steel plate	
Compressor	Type		-	Inverter Scroll	Inverter Scroll	
	Output		kW x n	(5.18) x 3 + (6.39) x 1	(5.18) x 2 + (6.39) x 2	
	Model Name		-	DS-GB052FAVB x 3 + DS-GB066FAVB x 1	DS-GB052FAVB x 2 + DS-GB066FAVB x 2	
	Oil	Type	-	PVE	PVE	
	Initial Charge		cc	(1,100 x 2)+(1,100 x 2)	(1,100 x 2)+(1,100 x 2)	
Condenser	Type		Type	PHE(Plate Heat Exchanger)	PHE(Plate Heat Exchanger)	
	Pipe Size		Ø, inch	PT1-1/4 x 3	PT1-1/4 x 3	
	Pressure Drop		kPa	30.0 + 43.0 + 54.0	43.0 x 2 + 54.0	
	Water Flow Rate		LPM	96.0 + 114.0 + 190.0	114.0 x 2 + 190.0	
	Max. Pressure		Mpa	1.96	1.96	
Piping Connections	Liquid Pipe		Type	Brazed connection	Brazed connection	
			Ø, mm	19.05	19.05	
			Ø, inch	3/4"	3/4"	
	Gas Pipe (Low pressure gas ref. pipe)		Type	Brazed connection	Brazed connection	
			Ø, mm	41.28	41.28	
			Ø, inch	1 5/8"	1 5/8"	
	Discharge Pipe (High pressure gas ref. pipe)		Type	Brazed connection	Brazed connection	
			Ø, mm	34.92	34.92	
		Ø, inch	1 3/8"	1 3/8"	1 3/8"	
	Heat insulation		-	Both liquid and gas pipes	Both liquid and gas pipes	
Piping length	ODU-IDU	Max.	m	170 (190)	170 (190)	
	After branch	Max.	m	90	90	
Total piping length	System	Actual	m	500	500	
Level difference	ODU-IDU	Outdoor unit in highest position	m	50	50	
		Indoor unit in highest position	m	40	40	
	IDU-IDU	Max.	m	50	50	
Wiring connections	Communication	Minimum	mm ²	0.75	0.75	
		Remark	-	F1, F2	F1, F2	
Refrigerant	Type		-	R410A	R410A	
	Factory Charging		kg	21.6	21.8	
Sound ³⁾	Sound Pressure	Cooling	dB(A)	54	54	
		Heating	dB(A)	56	56	
	Sound Power		dB(A)	76	77	
External Dimension	Net Weight		kg	160 x 2 + 240	160 x 2 + 240	
	Shipping Weight		kg	167 x 2 + 250	167 x 2 + 250	
	Net Dimensions (WxHxD)		mm	(770 x 1,000 x 545) x 2 + 1,100 x 1,000 x 545	(770 x 1,000 x 545) x 2 + 1,100 x 1,000 x 545	
			mm	(840 x 1,200 x 620) x 2 + 1,170 x 1,200 x 620	(840 x 1,200 x 620) x 2 + 1,170 x 1,200 x 620	
Operating Temp. Range	Cooling		°C	10.0 - 45.0	10.0 - 45.0	
	Heating		°C	10.0 - 45.0	10.0 - 45.0	

2. Specification

Premium energy efficiency Type

Type			DVM S Water	DVM S Water	DVM S Water		
Model Name	Outdoor unit module 1		AM500MXWA**	AM520MXWA**	AM600MXWA**		
	Outdoor unit module 2		AM100MXWA**	AM120MXWA**	AM200MXWA**		
	Outdoor unit module 3		AM200MXWA**	AM200MXWA**	AM200MXWA**		
	Outdoor unit module 4		-	-	-		
Power Supply	Ø, #, V, Hz		3,4,380-415,50/60	3,4,380-415,50/60	3,4,380-415,50/60		
Mode			HEAT RECOVERY	HEAT RECOVERY	HEAT RECOVERY		
Performance	HP	HP		50	52	60	
	Ton	Ton		39.81	41.4	47.77	
	Capacity	Cooling	kW		140.0	145.6	168.0
			Btu/h		477,700	496,800	573,200
			kW		157.5	163.8	189.0
		Heating 2**	Btu/h		537,400	558,900	644,900
			kW		-	-	-
Btu/h			-	-	-		
Maximum number of connectable indoor units	ea		64	64	64		
	Total capacity of the connected Indoor Units	Min.	kW	70.0	72.8	84.0	
		Max.	kW	182.0	189.3	218.4	
Power	Power Input	Cooling 1**	kW	25.21	26.41	32.31	
		Heating 2**	kW	25.69	26.76	32.58	
		Heating 4**	kW	-	-	-	
	Current Input	Cooling 1**	A	42.7	44.9	51.9	
		Heating 2**	A	43.2	45.2	52.2	
	Current	Minimum Ssc value	MVA	19.3	20.2	23.1	
		MCA	A	79.7	83.6	95.4	
MFA		A	90.0	100.0	125.0		
COP	Cooling 1**		W/W	5.55	5.51	5.20	
	Heating 2**		W/W	6.13	6.12	5.80	
	Heating 4**		W/W	-	-	-	
Casing	Material	Cabinet	-	Steel plate	Steel plate	Steel plate	
		Base	-	Steel plate	Steel plate	Steel plate	
Compressor	Type			Inverter Scroll	Inverter Scroll	Inverter Scroll	
	Output	kW × n		(5.18) × 5	(5.18) × 4 + (6.39) × 1	(5.18) × 6	
	Model Name			DS-GB052FAVB x 5	"DS-GB052FAVB x 4 + DS-GB066FAVB x 1"	DS-GB052FAVB x 6	
	Oil	Type			PVE	PVE	PVE
		Initial Charge	cc		1,100+((1,100x2) x 2)	1,100+((1,100x2) x 2)	(1,100 x 2) x 3
Condenser	Type	Type		PHE(Plate Heat Exchanger)	PHE(Plate Heat Exchanger)	PHE(Plate Heat Exchanger)	
	Pipe Size	Ø, inch		PT1-1/4 x 3	PT1-1/4 x 3	PT1-1/4 x 3	
	Pressure Drop	kPa		30.0 + 54.0 x 2	43.0 + 54.0 x 2	54.0 x 3	
	Water Flow Rate	LPM		96.0 + 190.0 x 2	114.0 + 190.0 x 2	190.0 x 3	
	Max. Pressure	Mpa		1.96	1.96	1.96	
Piping Connections	Liquid Pipe	Type		Brazed connection	Brazed connection	Brazed connection	
		Ø, mm		19.05	19.05	19.05	
		Ø, inch		3/4"	3/4"	3/4"	
	Gas Pipe (Low pressure gas ref. pipe)	Type		Brazed connection	Brazed connection	Brazed connection	
		Ø, mm		41.28	41.28	41.28	
		Ø, inch		1 5/8"	1 5/8"	1 5/8"	
	Discharge Pipe (High pressure gas ref. pipe)	Type		Brazed connection	Brazed connection	Brazed connection	
		Ø, mm		34.92	34.92	34.92	
		Ø, inch		1 3/8"	1 3/8"	1 3/8"	
	Heat insulation				Both liquid and gas pipes	Both liquid and gas pipes	Both liquid and gas pipes
	Piping length	ODU-IDU	Max.	m	170 (190)	170 (190)	170 (190)
After branch			m	90	90	90	
Total piping length	System	Actual	m	500	500	500	
Level difference	ODU-IDU	Outdoor unit in highest position	m	50	50	50	
		Indoor unit in highest position	m	40	40	40	
	IDU-IDU	Max.	m	50	50	50	
Wiring connections	Communication	Minimum	mm ²	0.75	0.75	0.75	
		Remark	-	F1, F2	F1, F2	F1, F2	
Refrigerant	Type		-	R410A	R410A	R410A	
	Factory Charging		kq	25.4	25.6	29.4	
Sound ³⁾	Sound Pressure	Cooling	dB(A)	54	54	55	
		Heating	dB(A)	56	57	57	
	Sound Power			dB(A)	77	77	78
External Dimension	Net Weight		kq	160 + 240 x 2	160 + 240 x 2	240 x 3	
	Shipping Weight		kq	167 + 250 x 2	167 + 250 x 2	250 x 3	
	Net Dimensions (WxHxD)		mm	770 x 1,000 x 545 + (1,100 x 1,000 x 545) x 2	770 x 1,000 x 545 + (1,100 x 1,000 x 545) x 2	(1,100 x 1,000 x 545) x 3	
	Shipping Dimensions (WxHxD)		mm	840 x 1,200 x 620 + (1,170 x 1,200 x 620) x 2	840 x 1,200 x 620 + (1,170 x 1,200 x 620) x 2	(1,170 x 1,200 x 620) x 3	
Operating Temp. Range	Cooling	°C		10.0 ~ 45.0	10.0 ~ 45.0	10.0 ~ 45.0	
	Heating	°C		10.0 ~ 45.0	10.0 ~ 45.0	10.0 ~ 45.0	

2. Specification

Premium compact type

Type			DVM S Water	DVM S Water	DVM S Water	DVM S Water	
Model Name	Outdoor unit module 1		AM300KXWANR	AM380MXWANR1	AM400MXWANR1	AM420MXWANR1	
	Outdoor unit module 2		AM300KXWANR	AM300KXWANR	AM300KXWANR	AM300KXWANR	
	Outdoor unit module 3		-	AM080MXWANR	AM100MXWANR	AM120MXWANR	
	Outdoor unit module 4		-	-	-	-	
Power Supply Mode			Ø, #, V, Hz	3, 4, 380-415, 50/60	3, 4, 380-415, 50/60	3, 4, 380-415, 50/60	3, 4, 380-415, 50/60
Mode			-	HEAT RECOVERY	HEAT RECOVERY	HEAT RECOVERY	HEAT RECOVERY
Performance	HP	HP	30	38	40	42	
	Ton	Ton	23.9	30.3	31.9	33.5	
	Capacity	Cooling	kW	84.0	106.4	112.0	117.6
			Btu/h	286,600	363,027	382,133	401,240
		Heating 2 ¹	kW	94.5	119.7	126.0	132.3
			Btu/h	322,400	408,373	429,867	451,360
	Heating 4 ¹	kW	74	-	-	-	
		Btu/h	252,500	-	-	-	
Maximum number of connectable indoor units	Total capacity of the connected Indoor Units	Min.	kW	42.0	53.2	56.0	58.8
		Max.	kW	109.2	138.3	145.6	152.9
		Cooling 3 ¹	kW	16.80	20.47	21.67	22.80
Power	Power Input	Heating 2 ¹	kW	16.88	20.85	21.92	23.13
		Heating 4 ¹	kW	15.42	-	-	-
		Cooling 3 ¹	A	26.4	32.6	34.5	36.7
	Current Input	Heating 2 ¹	A	26.5	33.1	34.9	36.9
		Minimum Ssc value	MVA	-	-	-	-
	Current	MCA	A	48	64.1	64.1	68
		MFA	A	63	75	75	75
		Cooling 3 ¹	W/W	5.00	5.20	5.17	5.16
COP	Heating 2 ¹	W/W	5.60	5.74	5.75	5.72	
	Heating 4 ¹	W/W	4.80	-	-	-	
	Cooling 3 ¹	W/W	5.00	5.20	5.17	5.16	
Casing	Material	Cabinet	-	Steel plate	Steel plate	Steel plate	Steel plate
		Base	-	Steel plate	Steel plate	Steel plate	Steel plate
Compressor	Type	-	-	Inverter Scroll	Inverter Scroll	Inverter Scroll	Inverter Scroll
	Output	-	-	Inverter Scroll	Inverter Scroll	Inverter Scroll	Inverter Scroll
	Model Name	-	-	DS-GB070FAVASG x 2	DS-GB070FAVASG x 2 + DS-GB052FAVB x 1	DS-GB070FAVASG x 2 + DS-GB052FAVB x 1	DS-GB070FAVASG x 2 + DS-GB066FAVB x 1
	Oil	Type	-	PVE	PVE	PVE	PVE
	Initial Charge	cc	1,100 x 2	(1,100 x 2) + 1,100	(1,100 x 2) + 1,100	(1,100 x 2) + 1,100	
Condenser	Type	Type	PHE(Plate Heat Exchanger)	PHE(Plate Heat Exchanger)	PHE(Plate Heat Exchanger)	PHE(Plate Heat Exchanger)	
	Pipe Size	Ø, inch	PT2	PT2 + PT1-1/4	PT2 + PT1-1/4	PT2 + PT1-1/4	
	Pressure Drop	kPa	50	50 + 22	50 + 30	50 + 43	
	Water Flow Rate	LPM	285	285 + 80	285 + 96	285 + 114	
	Max. Pressure	Mpa	1.96	1.96	1.96	1.96	
Piping Connections	Liquid Pipe	Type	Brazed connection	Brazed connection	Brazed connection	Brazed connection	
		Ø, mm	19.05	19.05	19.05	19.05	
		Ø, inch	3/4"	3/4"	3/4"	3/4"	
	Gas Pipe (Low pressure gas ref. pipe)	Type	Brazed connection	Brazed connection	Brazed connection	Brazed connection	
		Ø, mm	34.92	41.28	41.28	41.28	
		Ø, inch	1 3/8"	1 5/8"	1 5/8"	1 5/8"	
	Discharge Pipe (High pressure gas ref. pipe)	Type	Brazed connection	Brazed connection	Brazed connection	Brazed connection	
		Ø, mm	28.58	34.92	34.92	34.92	
		Ø, inch	1 1/8"	1 3/8"	1 3/8"	1 3/8"	
	Heat insulation	-	Both liquid and gas pipes	Both liquid and gas pipes	Both liquid and gas pipes	Both liquid and gas pipes	
	Piping length	ODU-IDU	Max.	m	170 (190)	170 (190)	170 (190)
		After branch	Max.	m	90	90	90
Total piping length	System	Actual	m	500	500	500	
Level difference	ODU-IDU	Outdoor unit in highest position	m	50	50	50	
		Indoor unit in highest position	m	40	40	40	
	IDU-IDU	Max.	m	50	50	50	
Wiring connections	Communication	Minimum	mm ²	0.75	0.75	0.75	
		Remark	-	F1, F2	F1, F2	F1, F2	
Refrigerant	Type	-	-	R-410A	R-410A	R-410A	
	Factory Charging	-	-	11.0	19.0	16.8	
Sound ³¹⁾	Sound Pressure	Cooling	dB(A)	56	57	57	
		Heating	dB(A)	58	59	59	
	Sound Power	-	dB(A)	75	77	77	
External Dimension	Net Weight	kg	280	160 + 280	160 + 280	160 + 280	
	Shipping Weight	kg	290	167 + 290	167 + 290	167 + 290	
	Net Dimensions (WxHxD)	mm	1100 x 1000 x 545	(770 X 1000 X 545)+ (1100 x 1000 x 545)	(770 X 1000 X 545)+ (1100 x 1000 x 545)	(770 X 1000 X 545)+ (1100 x 1000 x 545)	
	Shipping Dimensions (WxHxD)	mm	1170 x 1200 x 620	(840 X 1200 X 620)+ (1170 x 1200 x 620)	(840 X 1200 X 620)+ (1170 x 1200 x 620)	(840 X 1200 X 620)+ (1170 x 1200 x 620)	
Operating Temp. Range	Cooling	°C	10.0 - 45.0	10.0 - 45.0	10.0 - 45.0	10.0 - 45.0	
	Heating	°C	10.0 - 45.0	10.0 - 45.0	10.0 - 45.0	10.0 - 45.0	

2. Specification

Premium compact type

Type			DVM S Water	DVM S Water	DVM S Water	DVM S Water	
Model Name	Outdoor unit module 1		AM460MXWANR1	AM480MXWANR1	AM500MXWANR1	AM520MXWANR1	
	Outdoor unit module 2		AM300KXWANR	AM300KXWANR	AM300KXWANR	AM300KXWANR	
	Outdoor unit module 3		AM080MXWANR	AM100MXWANR	AM200MXWANR	AM120MXWANR	
	Outdoor unit module 4		AM080MXWANR	AM080MXWANR	-	AM100MXWANR	
Power Supply		Ø, #, V, Hz	3, 4, 380-415, 50/60	3, 4, 380-415, 50/60	3, 4, 380-415, 50/60	3, 4, 380-415, 50/60	
Mode			HEAT RECOVERY	HEAT RECOVERY	HEAT RECOVERY	HEAT RECOVERY	
Performance	HP	HP	46	48	50	52	
	Ton	Ton	36.6	38.2	39.8	41.4	
	Capacity	Cooling	kW	128.8	134.4	140.0	145.6
			Btu/h	439,453	458,560	477,667	496,773
			kW	144.9	151.2	157.5	163.8
		Heating 2 nd	Btu/h	494,347	515,840	537,333	558,827
			kW	-	-	-	-
Btu/h			-	-	-	-	
Maximum number of connectable indoor units	Total capacity of the connected Indoor Units	Min.	kW	64	64	64	
		Max.	kW	188.4	174.7	182.0	189.3
Power	Power Input	Cooling 1 st	kW	24.14	25.34	27.57	27.67
		Heating 2 nd	kW	24.82	25.89	27.74	28.17
		Heating 4 th	kW	-	-	-	-
	Current Input	Cooling 1 st	A	38.8	40.7	43.7	44.8
		Heating 2 nd	A	39.7	41.5	43.9	45.3
	Current	Minimum Ssc value	MVA	-	-	-	-
MCA		A	80.2	80.2	79.8	84.1	
MFA		A	90	90	90	100	
COP	Cooling 1 st	W/W	5.34	5.30	5.08	5.26	
	Heating 2 nd	W/W	5.84	5.84	5.68	5.81	
	Heating 4 th	W/W	-	-	-	-	
Casing	Material	Cabinet	-	Steel plate	Steel plate	Steel plate	
		Base	-	Steel plate	Steel plate	Steel plate	
Compressor	Type		-	Inverter Scroll	Inverter Scroll	Inverter Scroll	
	Output		kW × n	(6.75)x2 + (5.18)x2	(6.75)x2 + (5.18)x2	(6.75)x2 + (5.18)x2	(6.75)x2 + (6.39)x1 + (5.18)x1
	Model Name		-	DS-GB070FAVAVS G x 2 + DS-GB052FAVB x 2	DS-GB070FAVAVS G x 2 + DS-GB052FAVB x 2	DS-GB070FAVAVS G x 2 + DS-GB052FAVB x 2	DS-GB070FAVAVS G x 2 + DS-GB066FAVB x 1 + DS-GB052FAVB x 1
	Oil	Type	-	PVE	PVE	PVE	PVE
	Initial Charge	cc	(1,100 x 2) + (1,100)x2	(1,100 x 2) + (1,100)x2	(1,100 x 2)x2	(1,100 x 2) + (1,100)x2	
Condenser	Type		Type	PHE(Plate Heat Exchanger)	PHE(Plate Heat Exchanger)	PHE(Plate Heat Exchanger)	PHE(Plate Heat Exchanger)
	Pipe Size		Ø, inch	PT2 + PT1-1/4 x 2	PT2 + PT1-1/4 x 2	PT2 + PT1-1/4	PT2 + PT1-1/4 x 2
	Pressure Drop		kPa	50 + 22 x 2	50 + 22 + 30	50 + 54	50 + 43 + 30
	Water Flow Rate		LPM	285 + 80 x 2	285 + 80 + 96	285 + 190	285 + 114 + 96
	Max. Pressure		Mpa	1.96	1.96	1.96	1.96
Piping Connections	Liquid Pipe	Type		Brazed connection	Brazed connection	Brazed connection	Brazed connection
		Ø, mm	19.05	19.05	19.05	19.05	
		Ø, inch	3/4"	3/4"	3/4"	3/4"	
	Gas Pipe (Low pressure gas ref. pipe)	Type		Brazed connection	Brazed connection	Brazed connection	Brazed connection
		Ø, mm	41.28	41.28	41.28	41.28	
		Ø, inch	1 5/8"	1 5/8"	1 5/8"	1 5/8"	
	Discharge Pipe (High pressure gas ref. pipe)	Type		Brazed connection	Brazed connection	Brazed connection	Brazed connection
		Ø, mm	34.92	34.92	34.92	34.92	
		Ø, inch	1 3/8"	1 3/8"	1 3/8"	1 3/8"	
	Heat insulation			-	Both liquid and gas pipes	Both liquid and gas pipes	Both liquid and gas pipes
Piping length	ODU-IDU	Max.	m	170 (190)	170 (190)	170 (190)	170 (190)
	After branch	Max.	m	90	90	90	90
Total piping length	System	Actual	m	500	500	500	500
Level difference	ODU-IDU	Outdoor unit in highest position	m	50	50	50	50
		Indoor unit in highest position	m	40	40	40	40
	IDU-IDU	Max.	m	50	50	50	50
Wiring connections	Communication	Minimum	mm ²	0.75	0.75	0.75	0.75
		Remark		-	F1, F2	F1, F2	F1, F2
Refrigerant	Type		-	R-410A	R-410A	R-410A	R-410A
	Factory Charging		kg	22.0	22.3	20.8	22.8
Sound ³¹	Sound Pressure	Cooling	dB(A)	57	57	57	57
		Heating	dB(A)	59	59	59	60
	Sound Power		dB(A)	78	78	78	78
External Dimension	Net Weight		kg	160 X 2 + 280	160 X 2 + 280	240 + 280	160 X 2 + 280
	Shipping Weight		kg	167 X 2 + 290	167 X 2 + 290	250 + 290	167 X 2 + 290
	Net Dimensions (WxHxD)		mm	(770 X 1000 X 545) X 2+ (1100 x 1000 x 545)	(770 X 1000 X 545) X 2+ (1100 x 1000 x 545)	(1100 x 1000 x 545) X 2	(770 X 1000 X 545) X 2+ (1100 x 1000 x 545)
Shipping Dimensions (WxHxD)		mm	(840 X 1200 X 620) X 2+ (1170 x 1200 x 620)	(840 X 1200 X 620) X 2+ (1170 x 1200 x 620)	(1170 x 1200 x 620) X 2	(840 X 1200 X 620) X 2+ (1170 x 1200 x 620)	
Operating Temp. Range	Cooling		°C	10.0 ~ 45.0	10.0 ~ 45.0	10.0 ~ 45.0	10.0 ~ 45.0
	Heating		°C	10.0 ~ 45.0	10.0 ~ 45.0	10.0 ~ 45.0	10.0 ~ 45.0

2. Specification

Premium compact type

Type			DVM S Water	DVM S Water	DVM S Water	DVM S Water	
Model Name	Outdoor unit module 1		AM540MXWANR1	AM580MXWANR1	AM600MXWANR1	AM620MXWANR1	
	Outdoor unit module 2		AM300KXWANR	AM300KXWANR	AM300KXWANR	AM300KXWANR	
	Outdoor unit module 3		AM120MXWANR	AM200MXWANR	AM300KXWANR	AM200MXWANR	
	Outdoor unit module 4		AM120MXWANR	AM080MXWANR	-	AM120MXWANR	
Power Supply			Ø, #, V, Hz	3, 4, 380-415, 50/60	3, 4, 380-415, 50/60	3, 4, 380-415, 50/60	3, 4, 380-415, 50/60
Mode			-	HEAT RECOVERY	HEAT RECOVERY	HEAT RECOVERY	HEAT RECOVERY
Performance	HP	HP	54	58	60	62	
		Ton	43.0	46.2	47.8	49.4	
	Capacity	Cooling	kW	151.2	162.4	168.0	173.6
			Btu/h	515,880	554,093	573,200	592,307
		Heating ²⁾	kW	170.1	182.7	189.0	195.3
			Btu/h	580,320	623,307	644,800	666,293
		Heating ⁴⁾	kW	-	-	-	-
			Btu/h	-	-	-	-
Maximum number of connectable indoor units	Total capacity of the connected Indoor Units	Min.	kW	75.6	81.2	84.0	86.8
		Max.	kW	221.1	237.5	218.4	225.7
Power	Power Input	Cooling ¹⁾	kW	28.80	31.24	33.60	33.57
		Heating ²⁾	kW	29.38	31.71	33.76	33.99
		Heating ⁴⁾	kW	-	-	-	-
	Current Input	Cooling ¹⁾	A	47	49.9	52.8	54
		Heating ²⁾	A	47.3	50.5	53	54.3
	Current	Minimum Ssc value	MVA	-	-	-	-
MCA		A	88	95.9	96	99.8	
MFA		A	100	125	125	125	
COP	Cooling ¹⁾	W/W	5.25	5.20	5.00	5.17	
	Heating ²⁾	W/W	5.79	5.76	5.60	5.75	
	Heating ⁴⁾	W/W	-	-	-	-	
Casing	Material	Cabinet	-	Steel plate	Steel plate	Steel plate	Steel plate
		Base	-	Steel plate	Steel plate	Steel plate	Steel plate
Compressor	Type	-	Inverter Scroll	Inverter Scroll	Inverter Scroll	Inverter Scroll	
	Output	kW x n	(6.75)x2 + (6.39)x2	(6.75)x2 + (5.18)x3	6.75 x 4	(6.75)x2 + (5.18)x2 + (6.39)x1	
	Model Name	-	DS-GB070FAVASG x 2 + DS-GB066FAVB x 2	DS-GB070FAVASG x 2 + DS-GB052FAVB x 3	(DS-GB070FAVASG x 2) x 2	DS-GB070FAVASG x 2 + DS-GB052FAVB x 3 + DS-GB066FAVB x 1	
	Oil	Type	-	PVE	PVE	PVE	PVE
	Initial Charge	cc	(1,100 x 2) + (1,100)x2	(1,100 x 2)x2 + 1,100	(1,100 x 2)x2	(1,100 x 2)x2 + 1,100	
Condenser	Type	Type	PHE(Plate Heat Exchanger)	PHE(Plate Heat Exchanger)	PHE(Plate Heat Exchanger)	PHE(Plate Heat Exchanger)	
	Pipe Size	Ø, inch	PT2 + PT1-1/4 x 2	PT2 + PT1-1/4 x 2	PT2 x 2	PT2 + PT1-1/4 x 2	
	Pressure Drop	kPa	50 + 43x2	50 + 54 + 22	50 x 2	50 + 54 + 43	
	Water Flow Rate	LPM	285 + 114x2	285 + 190 + 80	285 x 2	285 + 190 + 114	
	Max. Pressure	Mpa	1.96	1.96	1.96	1.96	
Piping Connections	Liquid Pipe	Type	Brazed connection	Brazed connection	Brazed connection	Brazed connection	
		Ø, mm	19.05	19.05	19.05	22.22	
		Ø, inch	3/4"	3/4"	3/4"	7/8"	
	Gas Pipe (Low pressure gas ref. pipe)	Type	Brazed connection	Brazed connection	Brazed connection	Brazed connection	
		Ø, mm	41.28	41.28	41.28	53.98	
		Ø, inch	1 5/8"	1 5/8"	1 5/8"	2 1/8"	
	Discharge Pipe (High pressure gas ref. pipe)	Type	Brazed connection	Brazed connection	Brazed connection	Brazed connection	
		Ø, mm	34.92	34.92	34.92	41.28	
		Ø, inch	1 3/8"	1 3/8"	1 3/8"	1 5/8"	
	Heat insulation	-	Both liquid and gas pipes	Both liquid and gas pipes	Both liquid and gas pipes	Both liquid and gas pipes	
	Piping length	ODU-IDU	Max.	m	170 (190)	170 (190)	170 (190)
		After branch	Max.	m	90	90	90
Total piping length	System	Actual	m	500	500	500	
Level difference	ODU-IDU	Outdoor unit in highest position	m	50	50	50	
	IDU-IDU	Indoor unit in highest position	m	40	40	40	
Wiring connections	Communication	Minimum	mm ²	0.75	0.75	0.75	
	Remark	-	-	F1, F2	F1, F2	F1, F2	
Refrigerant	Type	-	-	R-410A	R-410A	R-410A	
	Factory Charging	kg	23.0	26.3	22.0	26.8	
Sound ³⁾	Sound Pressure	Cooling	dB(A)	57	58	60	58
		Heating	dB(A)	60	60	62	60
	Sound Power	-	-	78	78	79	78
External Dimension	Net Weight	kg	160 X 2 + 280	160 + 240 + 280	280 x 2	160 + 240 + 280	
	Shipping Weight	kg	167 X 2 + 290	167 + 250 + 290	290 x 2	167 + 250 + 290	
	Net Dimensions (WxHxD)	mm	(770 X 1000 X 545) X 2 + (1100 x 1000 x 545)	(770 X 1000 X 545) + (1100 x 1000 x 545) X 2	(1100 x 1000 x 545) x 2	(770 X 1000 X 545) + (1100 x 1000 x 545) X 2	
	Shipping Dimensions (WxHxD)	mm	(840 X 1200 X 620) X 2 + (1170 x 1200 x 620)	(840 X 1200 X 620) + (1170 x 1200 x 620) X 2	(1170 x 1200 x 620) x 2	(840 X 1200 X 620) + (1170 x 1200 x 620) X 2	
Operating Temp. Range	Cooling	°C	10.0 - 45.0	10.0 - 45.0	10.0 - 45.0	10.0 - 45.0	
	Heating	°C	10.0 - 45.0	10.0 - 45.0	10.0 - 45.0	10.0 - 45.0	

2. Specification

Premium compact type

Type			DVM S Water	DVM S Water	DVM S Water	DVM S Water		
Model Name	Outdoor unit module 1		AM680MXWANR1	AM700MXWANR1	AM800MXWANR1	AM900MXWANR1		
	Outdoor unit module 2		AM300KXWANR	AM300KXWANR	AM300KXWANR	AM300KXWANR		
	Outdoor unit module 3		AM300KXWANR	AM300KXWANR	AM300KXWANR	AM300KXWANR		
	Outdoor unit module 4		AM080MXWANR	AM100MXWANR	AM200MXWANR	AM300KXWANR		
Power Supply		Ø, #, V, Hz	3, 4, 380-415, 50/60	3, 4, 380-415, 50/60	3, 4, 380-415, 50/60	3, 4, 380-415, 50/60		
Mode			HEAT RECOVERY	HEAT RECOVERY	HEAT RECOVERY	HEAT RECOVERY		
Performance	HP	HP	68	70	80	90		
	Ton	Ton	54.2	55.8	63.7	71.7		
	Capacity	Cooling	kW	190.4	196.0	224.0	252.0	
			Btu/h	649,627	668,733	764,267	859,800	
		Heating 2 nd	kW	214.2	220.5	252.0	283.5	
			Btu/h	730,773	752,267	859,733	967,200	
		Heating 4 th	kW	-	-	-	-	
Btu/h			-	-	-	-		
Maximum number of connectable indoor units	ea	ea	64	64	64	64		
Power	Total capacity of the connected Indoor Units	Min.	kW	95.2	98.0	112.0	126.0	
		Max.	kW	2475	254.8	291.2	327.6	
	Power Input	Cooling 1 st	kW	37.27	38.47	44.37	50.40	
		Heating 2 nd	kW	37.73	38.80	44.62	50.64	
		Heating 4 th	kW	-	-	-	-	
	Current Input	Cooling 1 st	A	59	60.9	70.1	79.2	
		Heating 2 nd	A	59.6	61.4	70.4	79.5	
	Current	Minimum Ssc value	MVA	-	-	-	-	
		MCA	A	112.1	112.1	127.8	144	
		MFA	A	125	125	150	175	
COP	Cooling 1 st	W/W	5.11	5.09	5.05	5.00		
	Heating 2 nd	W/W	5.68	5.68	5.65	5.60		
	Heating 4 th	W/W	-	-	-	-		
Casing	Material	Cabinet	-	Steel plate	Steel plate	Steel plate		
		Base	-	Steel plate	Steel plate	Steel plate		
Compressor	Type		-	Inverter Scroll	Inverter Scroll	Inverter Scroll		
	Output		kW x n	(6.75)x4 + (5.18)x1	(6.75)x4 + (5.18)x1	(6.75)x4 + (5.18)x2	6.75 x 6	
	Model Name		-	DS-GB070FAVASG x 4 + DS-GB052FAVB x 1	DS-GB070FAVASG x 4 + DS-GB052FAVB x 1	DS-GB070FAVASG x 4 + DS-GB052FAVB x 2	(DS-GB070FAVASG x 2) x 3	
	Oil	Type		-	PVE	PVE	PVE	
		Initial Charge	cc	(1,100 x 2)x2 + 1,100	(1,100 x 2)x2 + 1,100	(1,100 x 2)x3	(1,100 x 2)x3	
Condenser	Type		Type	PHE(Plate Heat Exchanger)	PHE(Plate Heat Exchanger)	PHE(Plate Heat Exchanger)		
	Pipe Size	Ø, inch		PT2x2 + PT1-1/4	PT2x2 + PT1-1/4	PT2x2 + PT1-1/4	PT2 x 3	
	Pressure Drop	kPa		50x2 + 22	50x2 + 30	50x2 + 54	50 x 3	
	Water Flow Rate	LPM		285x2 + 80	285x2 + 96	285x2 + 190	285 x 3	
	Max. Pressure	Mpa		1.96	1.96	1.96	1.96	
Piping Connections	Liquid Pipe	Type		Brazed connection	Brazed connection	Brazed connection	Brazed connection	
		Ø, mm		22.22	22.22	22.22	22.22	
		Ø, inch		7/8"	7/8"	7/8"	7/8"	
	Gas Pipe (Low pressure gas ref. pipe)	Type		Brazed connection	Brazed connection	Brazed connection	Brazed connection	
		Ø, mm		53.98	53.98	53.98	53.98	
		Ø, inch		2 1/8"	2 1/8"	2 1/8"	2 1/8"	
	Discharge Pipe (High pressure gas ref. pipe)	Type		Brazed connection	Brazed connection	Brazed connection	Brazed connection	
		Ø, mm		41.28	41.28	41.28	41.28	
		Ø, inch		1 5/8"	1 5/8"	1 5/8"	1 5/8"	
	Heat insulation			-	Both liquid and gas pipes	Both liquid and gas pipes	Both liquid and gas pipes	
	Piping length	ODU-IDU	Max.	m	170 (190)	170 (190)	170 (190)	170 (190)
		After branch	Max.	m	90	90	90	90
	Total piping length	System	Actual	m	500	500	500	500
Level difference	ODU-IDU	Outdoor unit in highest position	m	50	50	50	50	
		Indoor unit in highest position	m	40	40	40	40	
	IDU-IDU	Max.	m	50	50	50	50	
Wiring connections	Communication	Minimum	mm ²	0.75	0.75	0.75	0.75	
		Remark		-	F1, F2	F1, F2	F1, F2	
Refrigerant	Type			R-410A	R-410A	R-410A	R-410A	
	Factory Charging		kq	27.5	27.8	31.8	33.0	
Sound ³⁾	Sound Pressure	Cooling	dB(A)	60	60	60	61	
		Heating		62	62	62	63	
External Dimension	Sound Power			79	79	80	80	
	Net Weight		kq	160 + 280 X 2	160 + 280 X 2	240 + 280 X 2	280 x 3	
	Shipping Weight		kq	167 + 290 X 2	167 + 290 X 2	250 + 290X 2	290 x 3	
	Net Dimensions (WxHxD)		mm	(770 X 1000 X 545) + (1100 X 1000 X 545) X 2	(770 X 1000 X 545) + (1100 X 1000 X 545) X 2	(1100 X 1000 X 545) X 3	(1100 X 1000 X 545) X 3	
Shipping Dimensions (WxHxD)		mm	(840 X 1200 X 620) + (1170 X 1200 X 620) X 2	(840 X 1200 X 620) + (1170 X 1200 X 620) X 2	(1170 X 1200 X 620) X 3	(1170 X 1200 X 620) X 3		
Operating Temp. Range	Cooling		°C	10.0 ~ 45.0	10.0 ~ 45.0	10.0 ~ 45.0	10.0 ~ 45.0	
	Heating		°C	10.0 ~ 45.0	10.0 ~ 45.0	10.0 ~ 45.0	10.0 ~ 45.0	

2. Specification

NOTE

- Specification may be subject to change without prior notice.
- 1) Cooling capacities are based on;
 - Indoor temperature : 27°C DB, 19°C WB, Inlet water temperature : 30°C, Equivalent refrigerant piping : 7.5m, Level differences : 0m
 - 2) Heating capacities are based on;
 - Indoor temperature : 20°C DB, 15°C WB, Inlet water temperature : 20°C, Equivalent refrigerant piping : 7.5m, Level differences : 0m
 - 3) Sound power level is an absolute value that a sound source generates.
 - Sound pressure level is a relative value, depending on the distance and acoustic environment.
 - Sound values are obtained in an anechoic room.
 - Sound values of multi combination are theoretical values based on sound results of individual installed units.
 - 4) Heating capacities are based on;
 - Indoor temperature : 20°C DB, 15°C WB, Inlet water temperature : 10°C, Outlet water temperature : 7°C, Equivalent refrigerant piping : 7.5m, Level differences : 0m
 - 5) These products contain R410A(GWP=2,088) which is fluorinated greenhouse gas.
 - 6) Total capacity of the connected indoor units can be allowed from 50% to 130% of the total outdoor unit capacity. $0.5 \times \Sigma(\text{Outdoor unit capacity}) \leq \text{Total capacity of the connected indoor units} \leq 1.3 \times \Sigma(\text{Outdoor unit capacity})$
 - 7) You can connect maximum 64 indoor units to the outdoor unit. Maximum quantity of connectable indoor unit is set to 64 since outdoor unit only support up to 64 communication address. Indoor unit address can be assigned from indoor unit address was assigned from 64~79, E201 error will occur. 0~63. If the indoor unit address was assigned from 64~79, E201 error will occur.

3. Electric Characteristics

Single

Capacity		Model	Power Supply		Voltage Range		Nominal Running Current [A]		Current [A]	
HP	kW		Hz	Voltage	Min. (-10%)	Max. (+10%)	Cooling	Heating	MCA	MFA
8	22.4	AM080MXWANR	50/60	380~415	342	456	6.2	6.6	16.1	20
10	28.0	AM100MXWANR	50/60	380~415	342	456	8.1	8.4	16.1	20
12	33.6	AM120MXWANR	50/60	380~415	342	456	10.3	10.4	20.0	25
20	56.0	AM200MXWANR	50/60	380~415	342	456	17.3	17.4	31.8	40
30	84.0	AM300KXWANR	50/60	380~415	342	456	26.4	26.5	48.1	63.1

Module (Premium energy efficiency type)

Capacity		Model	Power Supply		Voltage Range		Nominal Running Current [A]		Current [A]	
HP	kW		Hz	Voltage	Min. (-10%)	Max. (+10%)	Cooling	Heating	MCA	MFA
16	44.8	AM160MXWANR2	50/60	380~415	342	456	12.4	13.2	32.2	40
18	50.4	AM180MXWANR2	50/60	380~415	342	456	14.3	15	32.2	40
22	61.6	AM220MXWANR2	50/60	380~415	342	456	18.4	18.8	36.1	40
24	67.2	AM240MXWANR2	50/60	380~415	342	456	20.6	20.8	40.0	50
26	72.8	AM260MXWANR2	50/60	380~415	342	456	20.5	21.6	48.3	63
28	78.4	AM280MXWANR2	50/60	380~415	342	456	23.5	24	47.9	63
30	84.0	AM300MXWANR2	50/60	380~415	342	456	25.4	25.8	47.9	63
32	89.6	AM320MXWANR2	50/60	380~415	342	456	27.6	27.8	51.8	63
34	95.2	AM340MXWANR2	50/60	380~415	342	456	28.7	29.2	56.1	63
36	100.8	AM360MXWANR2	50/60	380~415	342	456	29.7	30.6	64.0	75
38	106.4	AM380MXWANR2	50/60	380~415	342	456	31.6	32.4	64.0	75
40	112.0	AM400MXWANR2	50/60	380~415	342	456	34.6	34.6	63.6	75
42	117.6	AM420MXWANR2	50/60	380~415	342	456	35.7	36.2	67.9	75
44	123.2	AM440MXWANR2	50/60	380~415	342	456	37.9	38.2	71.8	80
48	134.4	AM480MXWANR2	50/60	380~415	342	456	40.8	41.4	79.7	90
50	140.0	AM500MXWANR2	50/60	380~415	342	456	42.7	43.2	79.7	90
52	145.6	AM520MXWANR2	50/60	380~415	342	456	44.9	45.2	83.6	100
60	168.0	AM600MXWANR2	50/60	380~415	342	456	51.9	52.2	95.4	125

3. Electric Characteristics

Module (Premium compact type)

Capacity		Model	Power Supply		Voltage Range		Nominal Running Current [A]		Current [A]	
HP	kW		Hz	Voltage	Min. (-10%)	Max. (+10%)	Cooling	Heating	MCA	MFA
38	106.4	AM380MXWANR1	50/60	380~415	342	456	32.6	33.1	64.1	75
40	112.0	AM400MXWANR1	50/60	380~415	342	456	34.5	34.9	64.1	75
42	117.6	AM420MXWANR1	50/60	380~415	342	456	36.7	36.9	68.0	75
46	128.8	AM460MXWANR1	50/60	380~415	342	456	38.8	39.7	80.2	90
48	134.4	AM480MXWANR1	50/60	380~415	342	456	40.7	41.5	80.2	90
50	140.0	AM500MXWANR1	50/60	380~415	342	456	43.7	43.9	79.8	90
52	145.6	AM520MXWANR1	50/60	380~415	342	456	44.8	45.3	84.1	100
54	151.2	AM540MXWANR1	50/60	380~415	342	456	47	47.3	88.0	100
58	162.4	AM580MXWANR1	50/60	380~415	342	456	49.9	50.5	95.9	125
60	168.0	AM600MXWANR1	50/60	380~415	342	456	52.8	53	96.0	125
62	173.6	AM620MXWANR1	50/60	380~415	342	456	54	54.3	99.8	125
68	190.4	AM680MXWANR1	50/60	380~415	342	456	59	59.6	112.1	125
70	196.0	AM700MXWANR1	50/60	380~415	342	456	60.9	61.4	112.1	125
80	224.0	AM800MXWANR1	50/60	380~415	342	456	70.1	70.4	127.8	150
90	252.0	AM900MXWANR1	50/60	380~415	342	456	79.2	79.5	144.0	175

 **NOTE**

- MCA: Minimum circuit amperes
- MFA: Maximum fuse amperes
- Select wire size based on the value of MCA

4. Dimensional Drawing

AM080/100/120MXWA** (8, 10, 12HP)

Unit : mm

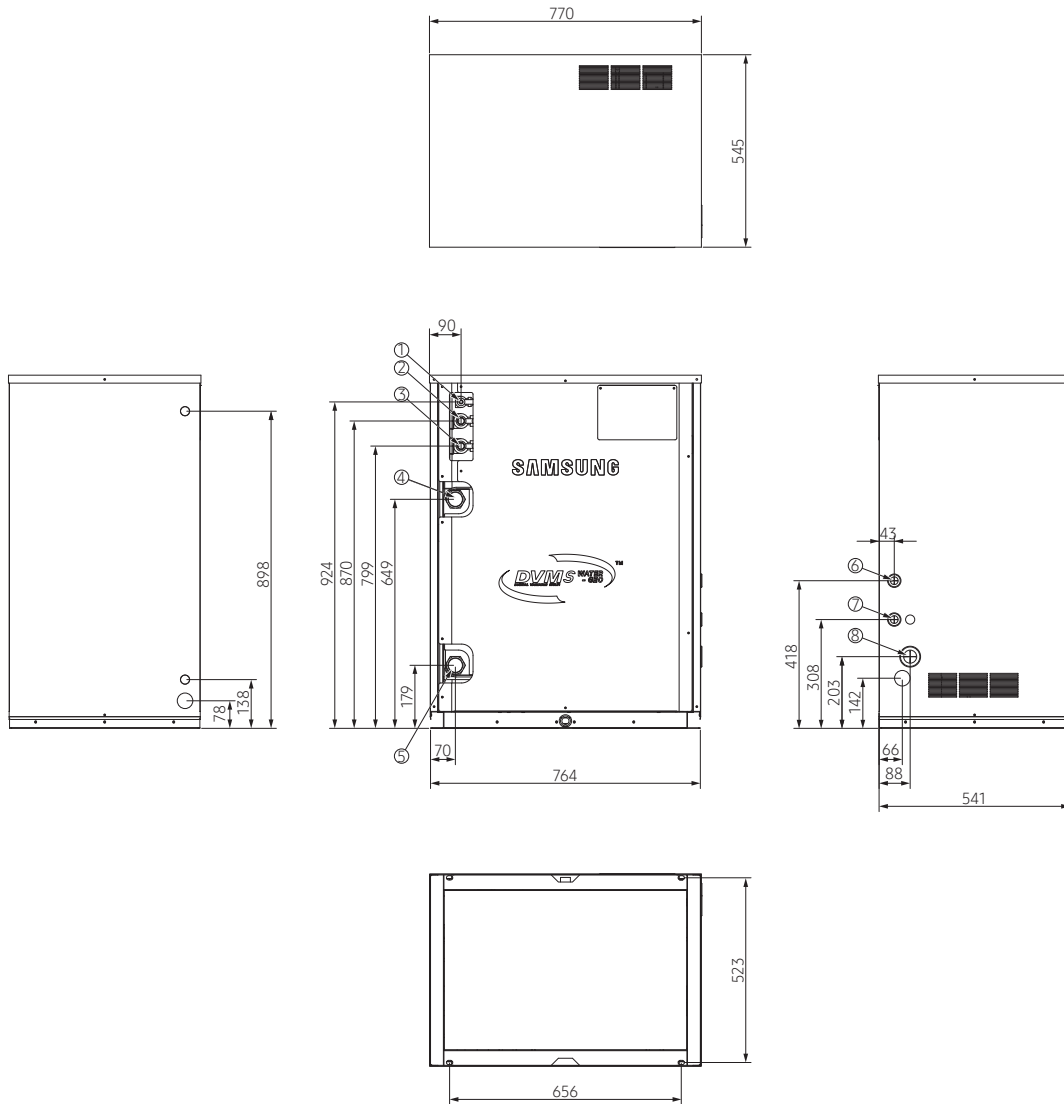

No.	Name	Description			No.	Name	Description		
		8HP	10HP	12HP			8HP	10HP	12HP
①	Liquid ref. pipe	9.52 (3/8")	9.52 (3/8")	12.70 (1/2")	⑤	Water inlet pipe	PT1-1/4		
②	High pressure gas ref. pipe	15.88 (5/8")	19.05 (3/4")	19.05 (3/4")	⑥	Communication wiring	-		
③	Low pressure gas ref. pipe	19.05 (3/4")	22.22 (7/8")	28.58 (1 1/8")	⑦	External contact wiring	-		
④	Water outlet pipe	PT1-1/4			⑧	Power wiring	-		

4. Dimensional Drawing

AM200MXWA** (20HP)

Unit : mm

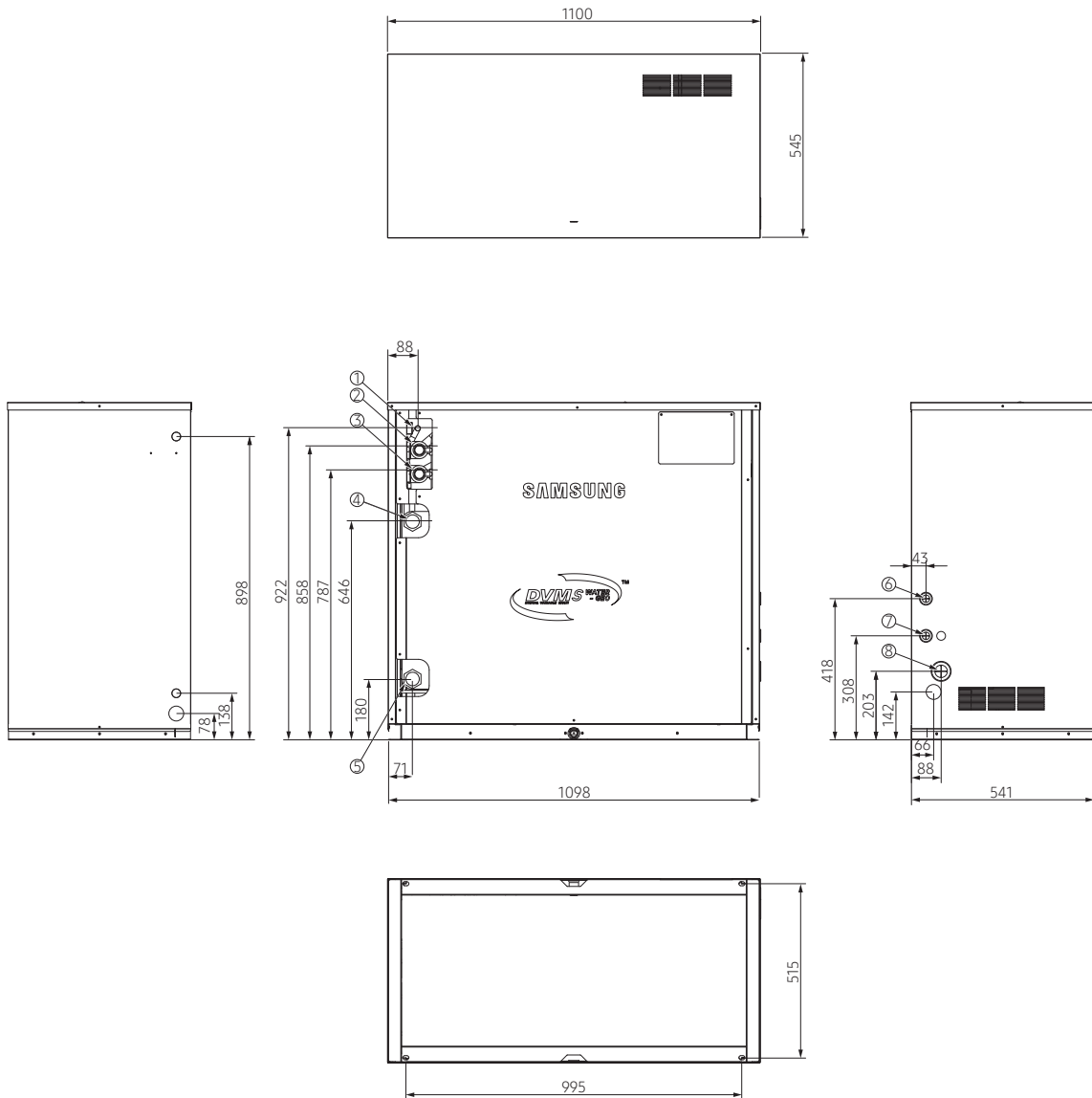

No.	Name	Description	No.	Name	Description
①	Liquid ref. pipe	15.88 (5/8")	⑤	Water inlet pipe	PT1-1/4
②	High pressure gas ref. pipe	28.58 (1 1/8")	⑥	Communication wiring	-
③	Low pressure gas ref. pipe	28.58 (1 1/8")	⑦	External contact wiring	-
④	Water outlet pipe	PT1-1/4	⑧	Power wiring	-

4. Dimensional Drawing

AM300KXWA** (30HP)

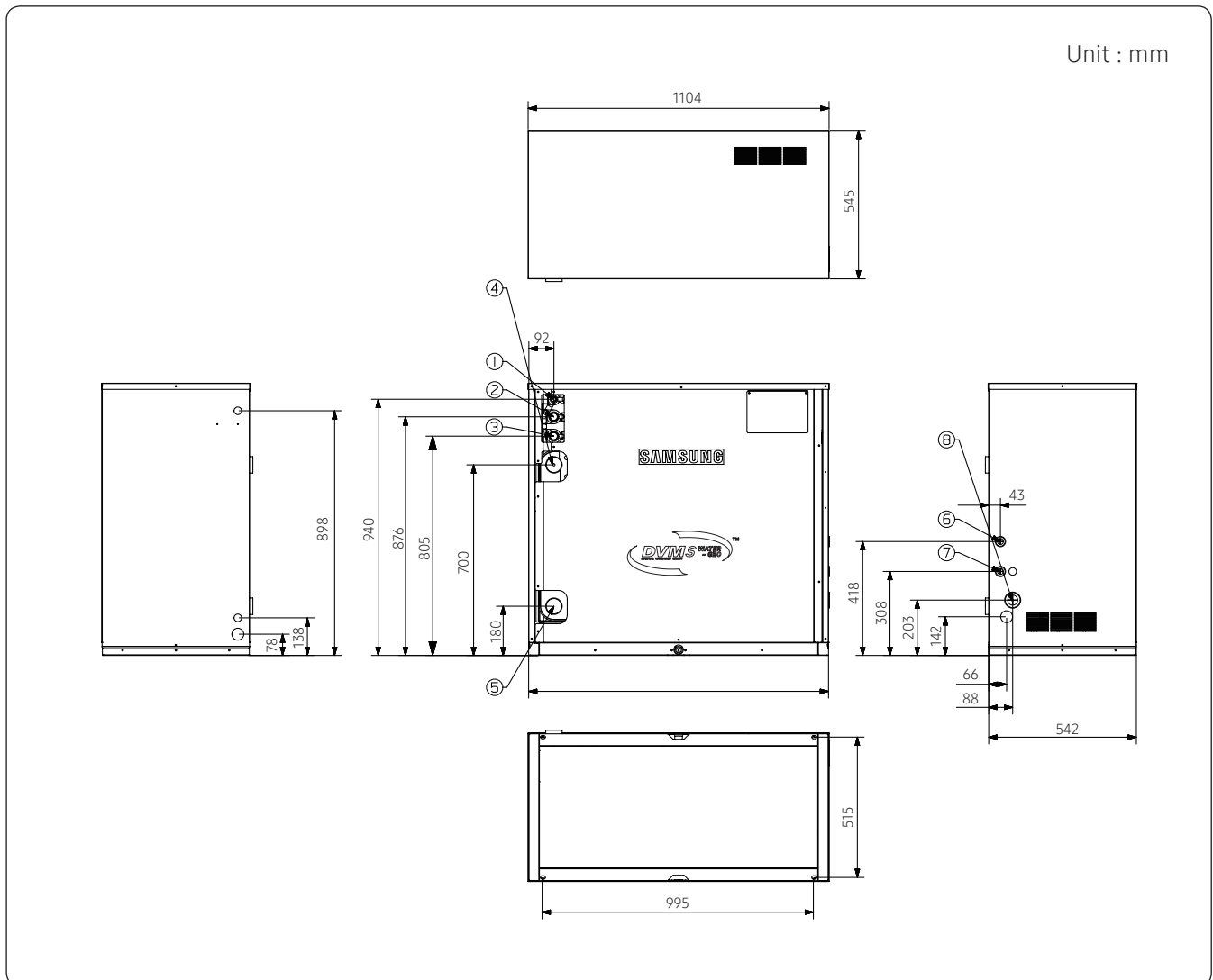

No.	Name	Description	No.	Name	Description
①	Liquid ref. pipe	Ø 19.05 (3/4")	⑤	Water inlet pipe	PT2
②	High pressure gas ref. pipe	Ø 34.92 (1 3/8")	⑥	Communication wiring	-
③	Low pressure gas ref. pipe	Ø 28.58 (1 1/8")	⑦	External contact wiring	-
④	Water outlet pipe	PT2	⑧	Power wiring	-

5. Center of Gravity

AM080/100/120MXWA** (8, 10, 12HP)

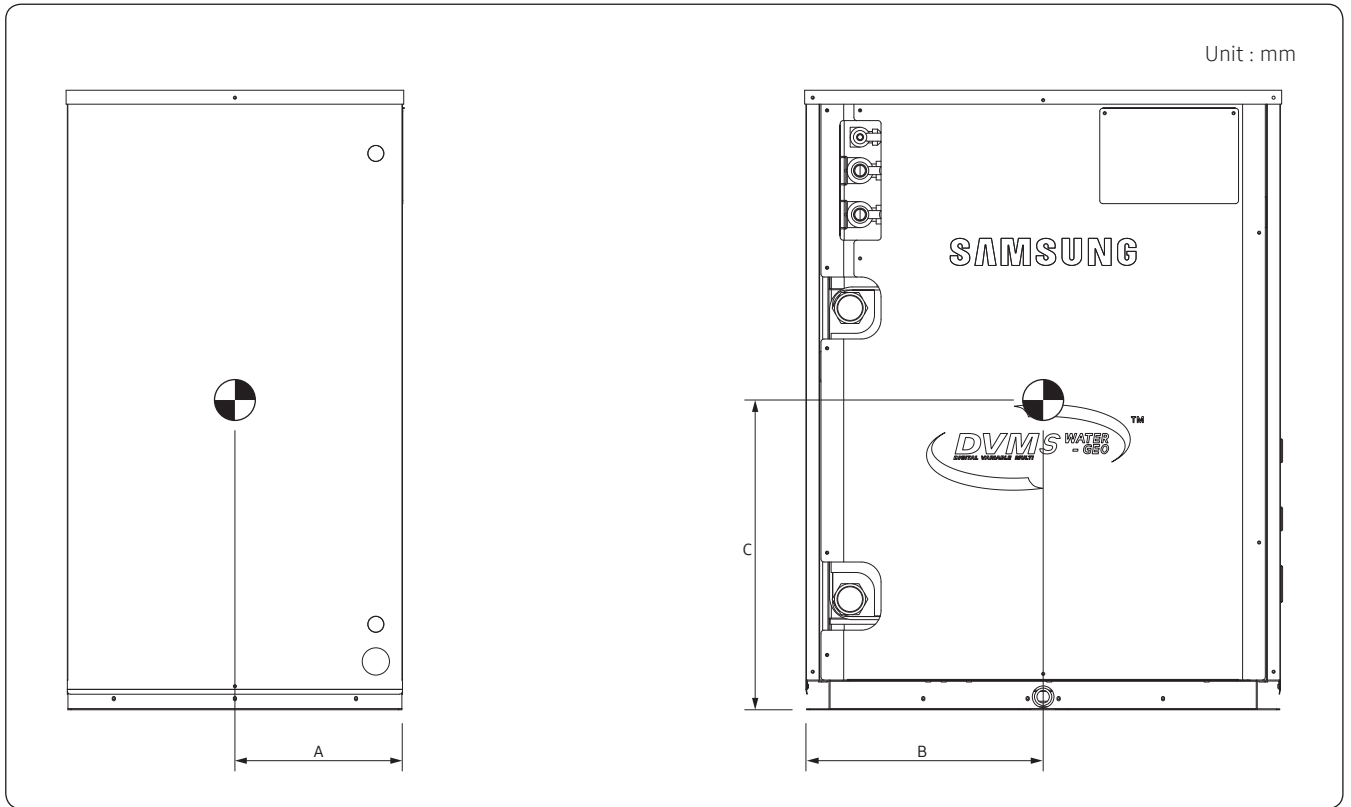

Model	A	B	C
AM080/100/120MXWA**	211	345	353

5. Center of Gravity

AM200MXWA**, AM300KXWA** (20, 30HP)

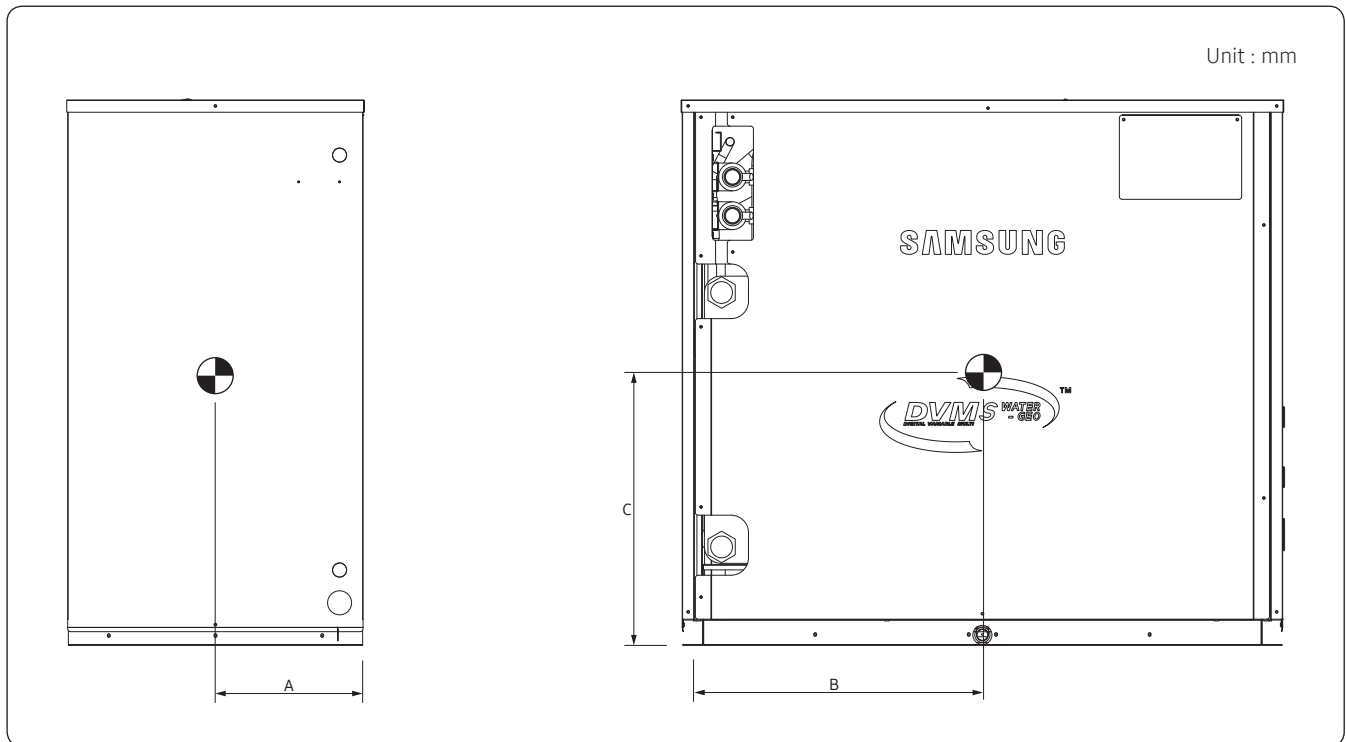

Model	A	B	C
AM200MXWA**	210	476	362
AM300KXWA**	206	461	390

6. Electrical Wiring Diagram

AM080MXWA**~AM200MXWA** (8~20HP)**

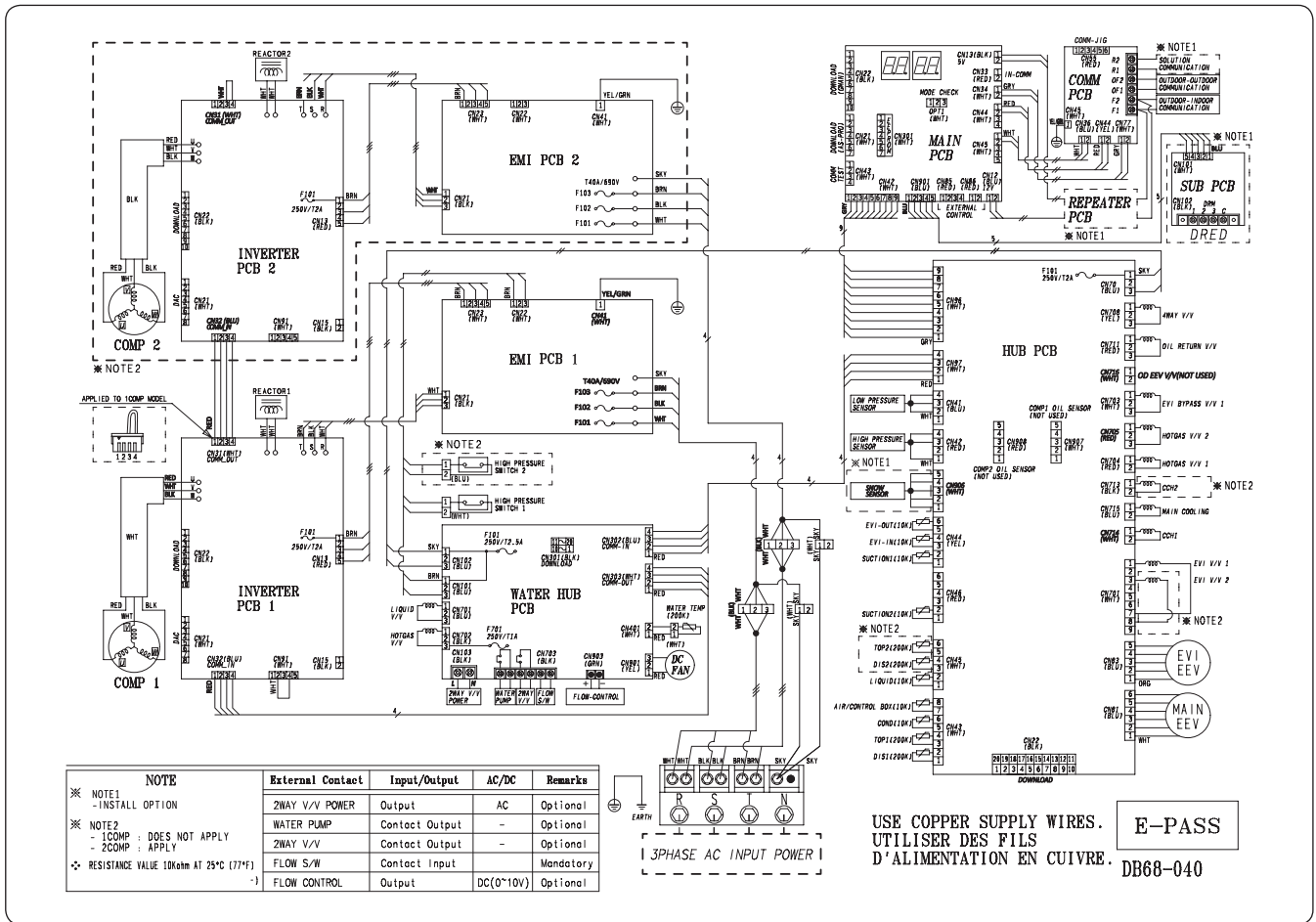

INVERTER PCB1	Printed circuit board (Inverter PBA1)	EEV1	Electrical Expansion Valve 1	HOTGAS V/V1	Solenoid Valve (Hot Gas Bypass1)
INVERTER PCB2	Printed circuit board (Inverter PBA2)	EEV2	Electrical Expansion Valve 2	HOTGAS V/V 2	Solenoid Valve (Hot Gas Bypass2)
EMI PCB1	Printed circuit board (Noise Filter1)	EVI-OUT (10K)	Temp. Sensor (EVI-out_10kohm)	EVI BYPASS V/V1	Solenoid Valve (EVI Bypass)
EMI PCB2	Printed circuit board (Noise Filter2)	EVI-IN (10K)	Temp. Sensor (EVI-in_10Kohm)	OIL RETURN V/V	Solenoid Valve (Accumulator Oil Return)
WATER HUB PCB	Printed circuit board (Water related load control)	COMP SUCTION1 (10K)	Temp. Sensor (COMP Suction TEMP.1_10Kohm)	4WAY V/V	Solenoid Valve (4Way Valve)
MAIN PCB	Printed circuit board (main)	COMP SUCTION2 (10K)	Temp. Sensor (COMP Suction TEMP.2_10Kohm)	CCH1	Crank Case Heater (COMP1)
HUB PCB	Printed circuit board (hub)	CONTROL BOX TEMP	Temp. Sensor (Inside TEMP. of Control Box_10Kohm)	CCH2	Crank Case Heater (COMP2)
COMM PCB	Printed circuit board (Communication)	CONDENSER OUT (10K)	Temp. Sensor (Condenser Out_Temp_10Kohm)	MAIN COOLING	Solenoid Valve (Main Cooling)
COMP1	Motor (Compressor1)	COMP TOP1 (200K)	Temp. Sensor (Compressor1_200Kohm)	F101 250V/T2A	FUSE (INVERTER PBA)
COMP2	Motor (Compressor2)	COMP TOP2 (200K)	Temp. Sensor (Compressor2_200Kohm)	690V/T40A	FUSE (NOISE FILTER)
EVI V/V1	Solenoid Valve (EVI 1)	DISCHARGE1 (200K)	Temp. Sensor (COMP Discharge.1_200Kohm)	F101 250V/T2.5A	FUSE (WATER HUB)
EVI V/V 2	Solenoid Valve (EVI 2)	DISCHARGE2 (200K)	Temp. Sensor (COMP Discharge.2_200Kohm)	F701 250V/T1A	FUSE (WATER HUB)
EVI EEV	Enhanced Vapor Injection Electrical Expansion Valve	LIQUID TUBE (10K)	TEMP. Sensor (Liquid Tube Temp. 10Kohm)		

NOTE

- This wiring diagram applies only to the water-cooled DVM S Water.
- Colors BLK: black, RED: red, BLU: blue, WHT: white, YEL: yellow, BRN: brown, SKY: skyblue
- When operating, don't short circuit the protection device (High Pressure switch)
- For connection wiring indoor-outdoor transmission F1-F2, outdoor-outdoor transmission OF1-OF2, refer to the installation manual.
- Protective earth (screw), connector, : The wire quantity

6. Electrical Wiring Diagram

AM300KXWA** (30HP)

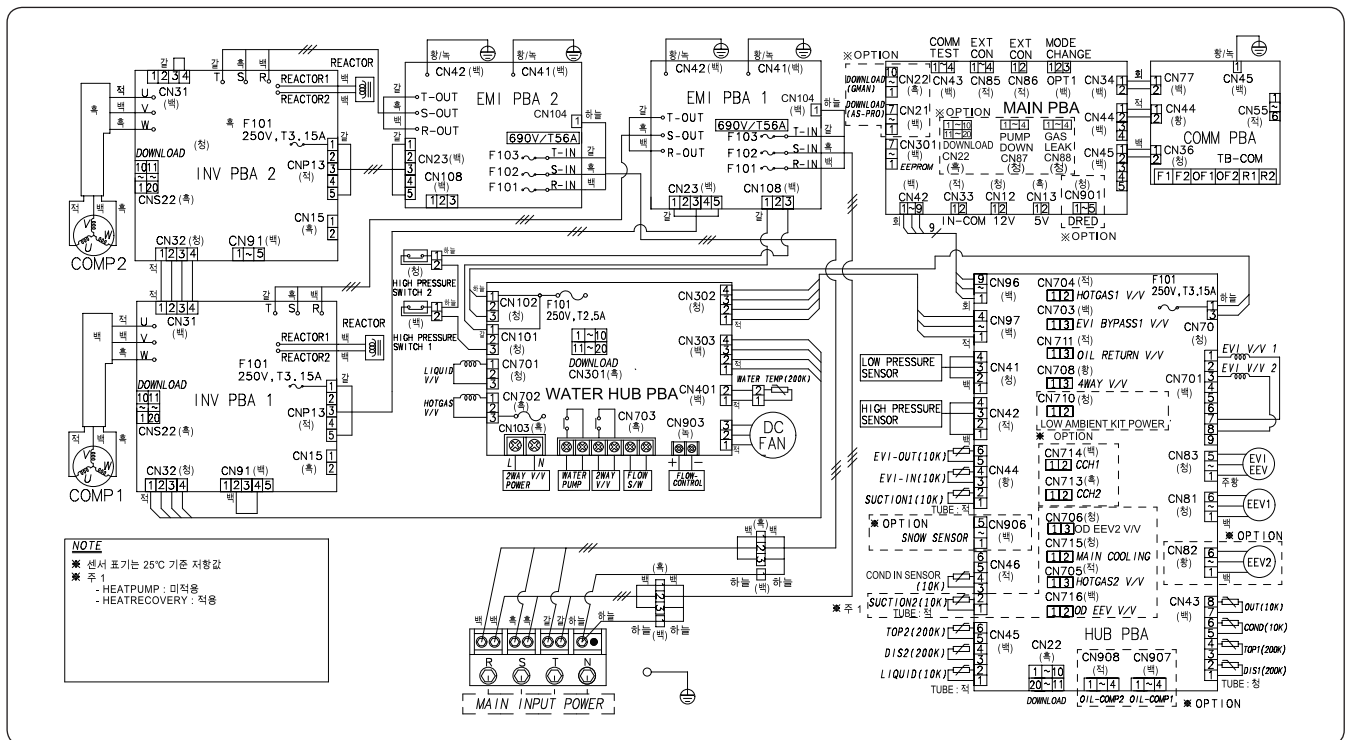

INV PBA1	Printed circuit board(Inverter PBA1)	EEV1	Electrical Expansion Valve 1	LIQUID(10K)	Temp. Sensor (Liquid Tube Temp. 10Kohm)
INV PBA2	Printed circuit board(Inverter PBA2)	EEV2	Electrical Expansion Valve 2	HOTGAS1 V/V	Solenoid Valve (Hot Gas Bypass1)
EMI PBA1	Printed circuit board(Noise Filter1)	EVI-OUT(10K)	Temp. Sensor (EVI-out 10kohm)	EVI BYPASS V/V	Solenoid Valve (EVI Bypass)
EMI PBA2	Printed circuit board(Noise Filter2)	EVI-IN(10K)	Temp. Sensor (EVI-in 10kohm)	RETURN V/V	Solenoid Valve (Accumulator Oil Return)
WATER HUB PCB	Printed circuit board(Water related load control)	SUCTION1(10K)	Temp. Sensor (Suction Temp.1 10Kohm)	4WAY V/V	Solenoid Valve (4Way Valve)
MAIN PBA	Printed circuit board(main)	SUCTION2(10K)	Temp. Sensor (Suction Temp.2 10Kohm)	CCH1	Crank Case Heater(COMP1)
HUB PBA	Printed circuit board(hub)	SNOW SENSOR	SNOW SENSOR	CCH2	Crank Case Heater(COMP2)
COMM PBA	Printed circuit board(Communication)	OIL-COMP1	Oil-Sensor (Compressor1)	MAIN COOLING	Solenoid Valve (Main Cooling)
COMP1	Motor (Compressor1)	OIL-COMP2	Oil-Sensor (Compressor2)	HOTGAS2 V/V	Solenoid Valve (Hot Gas Bypass2)
COMP2	Motor (Compressor2)	OUT(10K)	Temp. Sensor (Ambient Temp. 10Kohm)	OD EEV V/V	Solenoid Valve (Outdoor EEV)
FAN1	Motor (Outdoor Fan1)	COND(10K)	Temp. Sensor (Cond Out Temp. 10Kohm)	690V/T56A	FUSE(NOISE FILTER)
FAN2	Motor (Outdoor Fan1)	TOP1(200K)	Temp. Sensor (Compressor Top1 200Kohm)	MODE CHANGE	Connector (Remote switching cool/heat selector)
EVI V/V1	Solenoid Valve(EVI 1)	TOP2(200K)	Temp. Sensor (Compressor Top2 200Kohm)	EXT CON	Connector (Output EXT CON)
EVI V/V 2	Solenoid Valve(EVI 2)	DIS1(200K)	Temp. Sensor (Discharge Temp.1 200Kohm)	ERROR/COMP EXT	Connector (Output ERROR/COMP EXT CON)
EVI EEV	Enhanced Vapor Injection Electrical Expansion Valve	DIS2(200K)	Temp. Sensor (Discharge Temp.2 200Kohm)		

NOTE

- This wiring diagram applies only to the water-cooled DVM S Water.
- Colors BLK: black, RED: red, BLU: blue, WHT: white, YEL: yellow, BRN: brown, SKY: skyblue
- When operating, don't short circuit the protection device (High Pressure switch)
- For connection wiring indoor-outdoor transmission F1-F2, outdoor-outdoor transmission OF1-OF2, refer to the installation manual.
- Protective earth (screw), connector, : The wire quantity

7. Sound Level

Summary

Single

Capacity		Model	Sound Pressure dB(A)		Sound Power (dBA)
HP	KW		Cooling	Heating	
8	22.4	AM080MXWANR	45	46	70
10	28.0	AM100MXWANR	47	49	70
12	33.6	AM120MXWANR	47	50	70
20	56.0	AM200MXWANR	50	52	73
30	84.0	AM300KXWANR	56	58	75

Module (Premium energy efficiency type)

Capacity		Model	Sound Pressure dB(A)		Sound Power (dBA)
HP	KW		Cooling	Heating	
16	44.8	AM160MXWANR2	49	50	73
18	50.4	AM180MXWANR2	50	51	73
22	61.6	AM220MXWANR2	51	53	73
24	67.2	AM240MXWANR2	51	54	73
26	72.8	AM260MXWANR2	51	53	75
28	78.4	AM280MXWANR2	52	53	75
30	84.0	AM300MXWANR2	52	54	75
32	89.6	AM320MXWANR2	52	55	75
34	95.2	AM340MXWANR2	52	55	75
36	100.8	AM360MXWANR2	53	54	76
38	106.4	AM380MXWANR2	53	55	76
40	112.0	AM400MXWANR2	54	56	76
42	117.6	AM420MXWANR2	54	56	76
44	123.2	AM440MXWANR2	54	56	76
48	134.4	AM480MXWANR2	54	56	77
50	140.0	AM500MXWANR2	54	56	77
52	145.6	AM520MXWANR2	54	57	77
60	168.0	AM600MXWANR2	55	57	78

7. Sound Level

Summary

Module (Premium compact type)

Capacity		Model	Sound Pressure dB(A)		Sound Power (dBA)
HP	KW		Cooling	Heating	
38	106.4	AM380MXWANR1	57	59	77
40	112.0	AM400MXWANR1	57	59	77
42	117.6	AM420MXWANR1	57	59	77
46	128.8	AM460MXWANR1	57	59	78
48	134.4	AM480MXWANR1	57	59	78
50	140.0	AM500MXWANR1	57	59	78
52	145.6	AM520MXWANR1	57	60	78
54	151.2	AM540MXWANR1	57	60	78
58	162.4	AM580MXWANR1	58	60	78
60	168.0	AM600MXWANR1	60	62	79
62	173.6	AM620MXWANR1	58	60	78
68	190.4	AM680MXWANR1	60	62	79
70	196.0	AM700MXWANR1	60	62	79
80	224.0	AM800MXWANR1	60	62	80
90	252.0	AM900MXWANR1	61	63	80

NOTE

- Sound Pressure Level
 - Sound Pressure level is obtained in an anechoic room.
 - Sound Pressure level is a relative value, depending on the distance and acoustic environment.
 - Sound Pressure level may differ depending on operation condition.
 - dBA = A-weighted sound power level.
 - Reference acoustic pressure 0 dB = 20μPa
- Sound Power Level
 - Sound power level is an absolute value that a sound source generates.
 - dBA = A-weighted sound power level.
 - Reference power: 1pW.
 - Measured according to ISO 3741.

7. Sound Data

Sound Pressure level

Unit: dB(A)

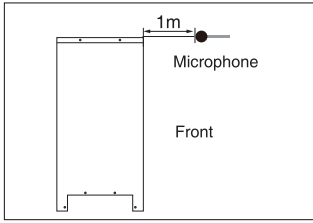

Model	Cooling
AM080MXWA**	45
AM100MXWA**	47
AM120MXWA**	47
AM200MXWA**	50
AM300KXWA**	56

NR Curve

1) AM080MXWA**

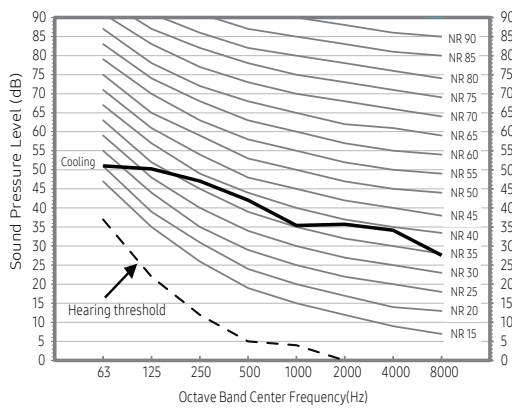

2) AM100MXWA**

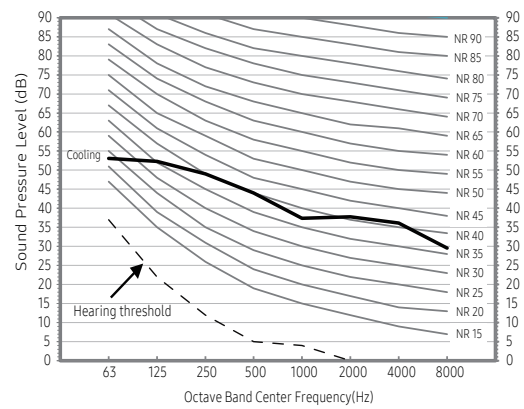

3) AM120MXWA**

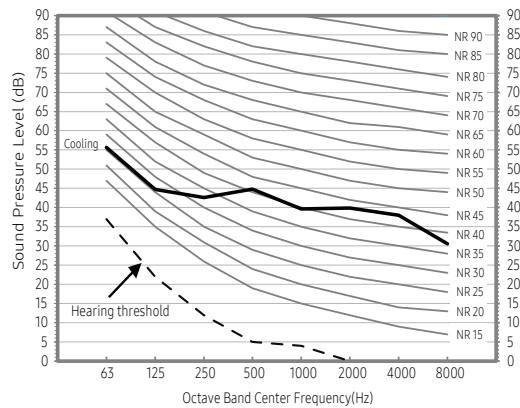

4) AM200MXWA**

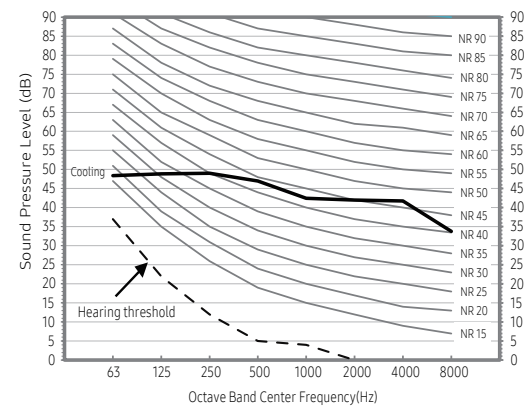

5) AM300KXWA**

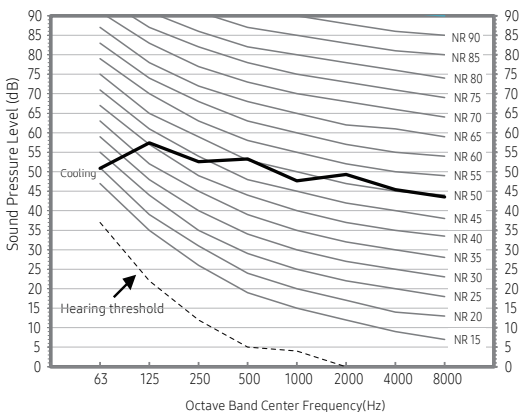

7. Sound Data

Sound Power Level

Unit: dB(A)

Model	Power
AM080MXWA**	70
AM100MXWA**	70
AM120MXWA**	70
AM200MXWA**	73
AM300KXWA**	75

1) AM080FXWA**

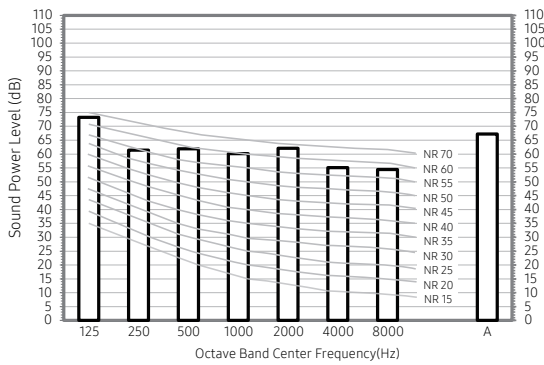

2) AM100FXWA**

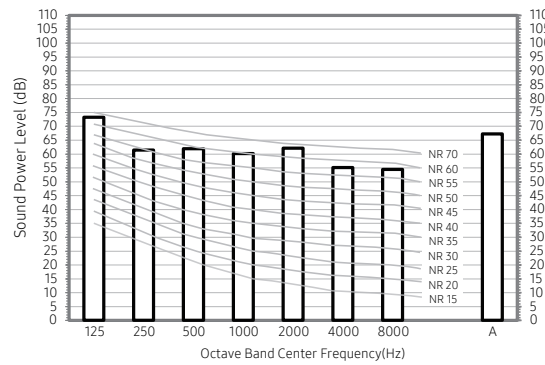

3) AM120FXWA**

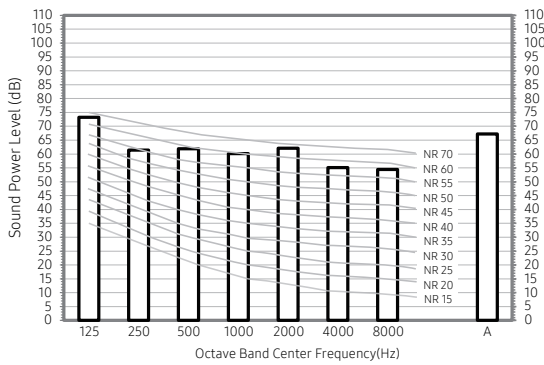

4) AM200FXWA**

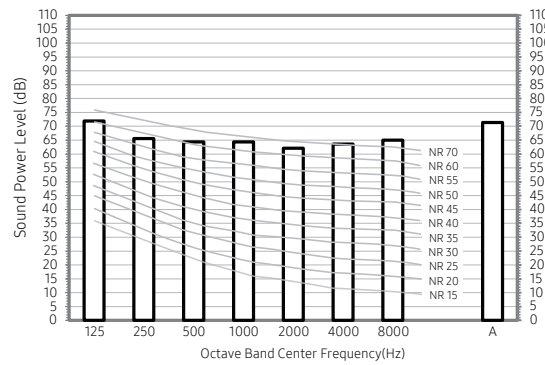

5) AM300KXWA**

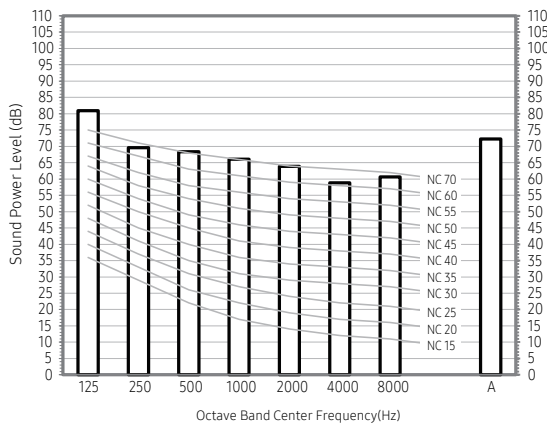

8. Operating Range

Cooling

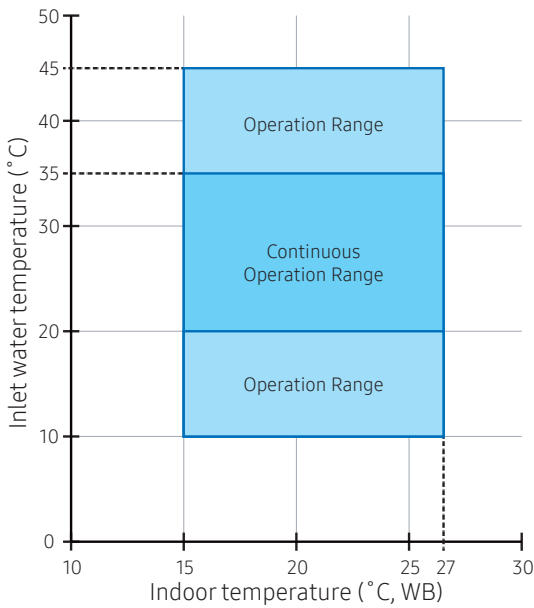

NOTE

- In the range except for the continuous operation range, the protection control can be active depending on the heat source flow rate. (It is not a failure but a way of cycle protection against hot or cold water.)

Heating

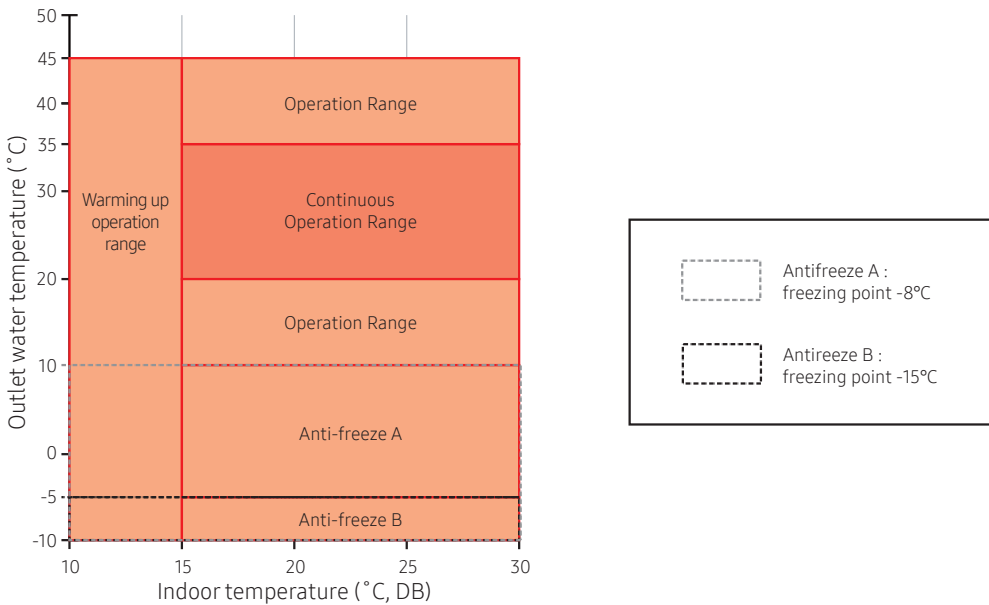

NOTE

- In the range except for the continuous operation range, the protection control can be active depending on the heat source flow rate. (It is not a failure but a way of cycle protection against hot or cold water.)
- For use in the antifreeze condition, the antifreeze concentration must be rigidly managed.

8. Operating Range

Heat Recovery

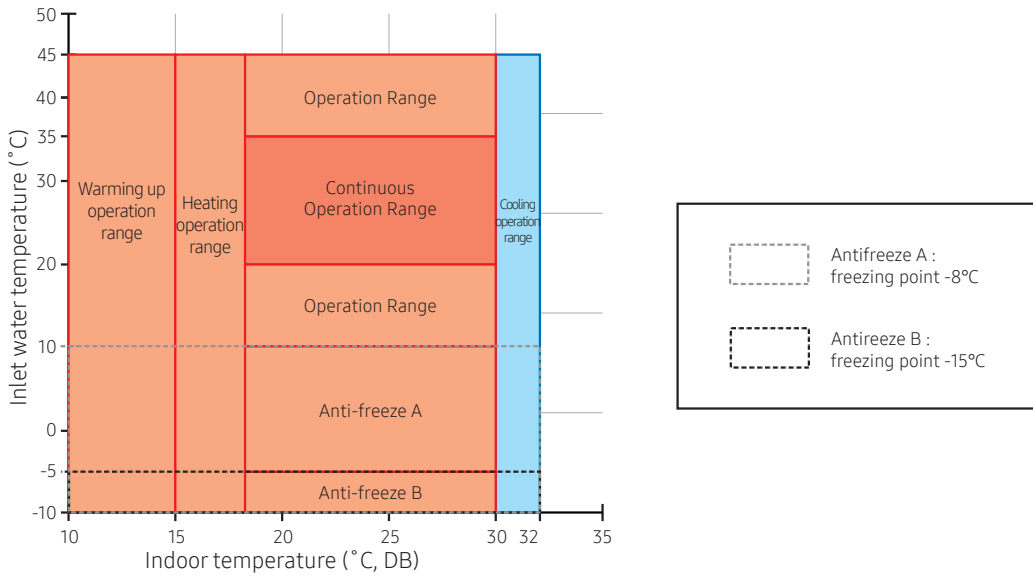

NOTE

- In the range except for the continuous operation range, the protection control can be active depending on the heat source flow rate. (It is not a failure but a way of cycle protection against hot or cold water.)
- For use in the antifreeze condition, the antifreeze concentration must be rigidly managed.

Design standard

Type	Circulating water	Operation	Inlet water temperature (°C)		
			Standard	Main usage	Operation limit
Heat source water	Water loop	Cooling	30	20~35	10~45
		Heating	20	20~35	
Ground heat source ¹⁾	Ground water	Cooling	15	15~35	Cooling: 10~45 Heating: -5~45 (Heating: -5~45) ²⁾
		Heating	10	5~25	
	Ground loop	Cooling	25	15~35	
		Heating	5	5~25	

1) Anti-freeze must be used when temperature of water inlet for heating is below 10°C or ground heat is used.

Maintain appropriate concentration level of anti-freeze according to temperature of water inlet.

2) Strict management of anti-freeze concentration level is required. Consult Samsung before application.

Anti-freeze standard

Type of anti-freeze (Based on 15°C)	Concentration [% Wt.]	Freezing temperature [°C]	Density [kg/m ³]
Ethylene glycol	10	-3.2	1014.87
	20	-7.8	1031.39
	30	-14.1	1047.07
	40	-22.3	1061.65
Propylene glycol	10	-3.3	1009.75
	20	-7.1	1020.91
	30	-12.7	1030.51
	40	-21.1	1038.65

8. Operating Range

Water Flow rate

Section	Water Flow Rate (LPM)				
	8HP	10HP	12HP	20HP	30HP
Standard condition	80	96	114	190	285
Operation range	48~96	58~115	68~137	114~228	170~342

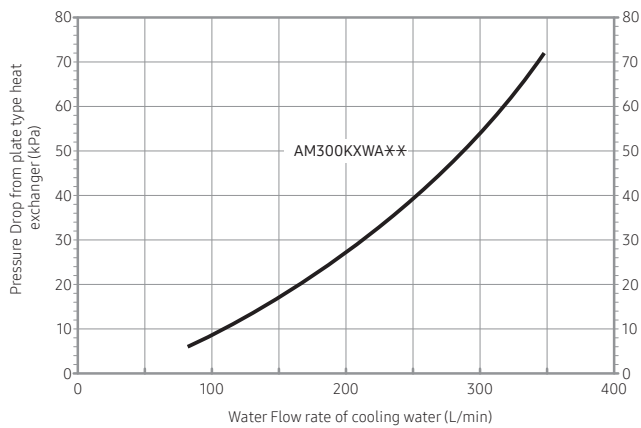
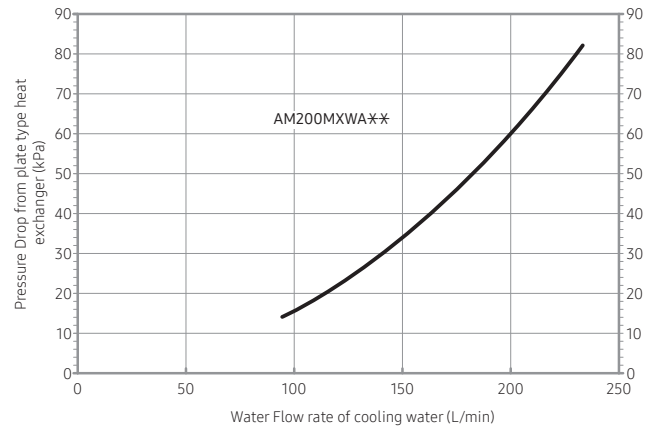
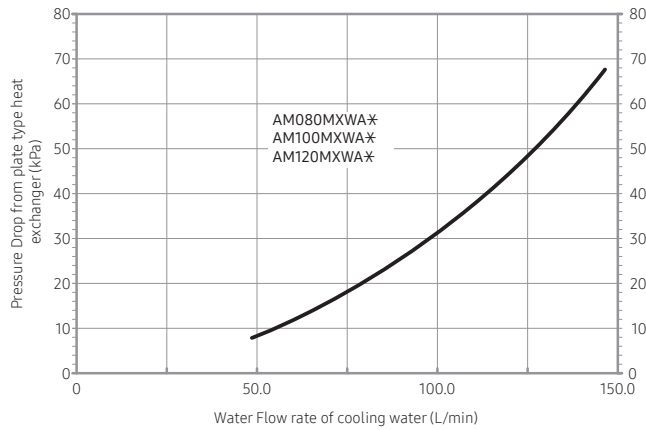

NOTE

- When the water flow rate is out of the operation range, stop the outdoor unit and take care of the cause before restarting the operation. (Allowable range: 60~120% of the standard water flow rate)
- For the piping work, set the pump capacity considering the pressure drop of the plate heat exchanger to maintain a proper flow rate.

9. Piping Diagram

AM080/100/120MXWA**

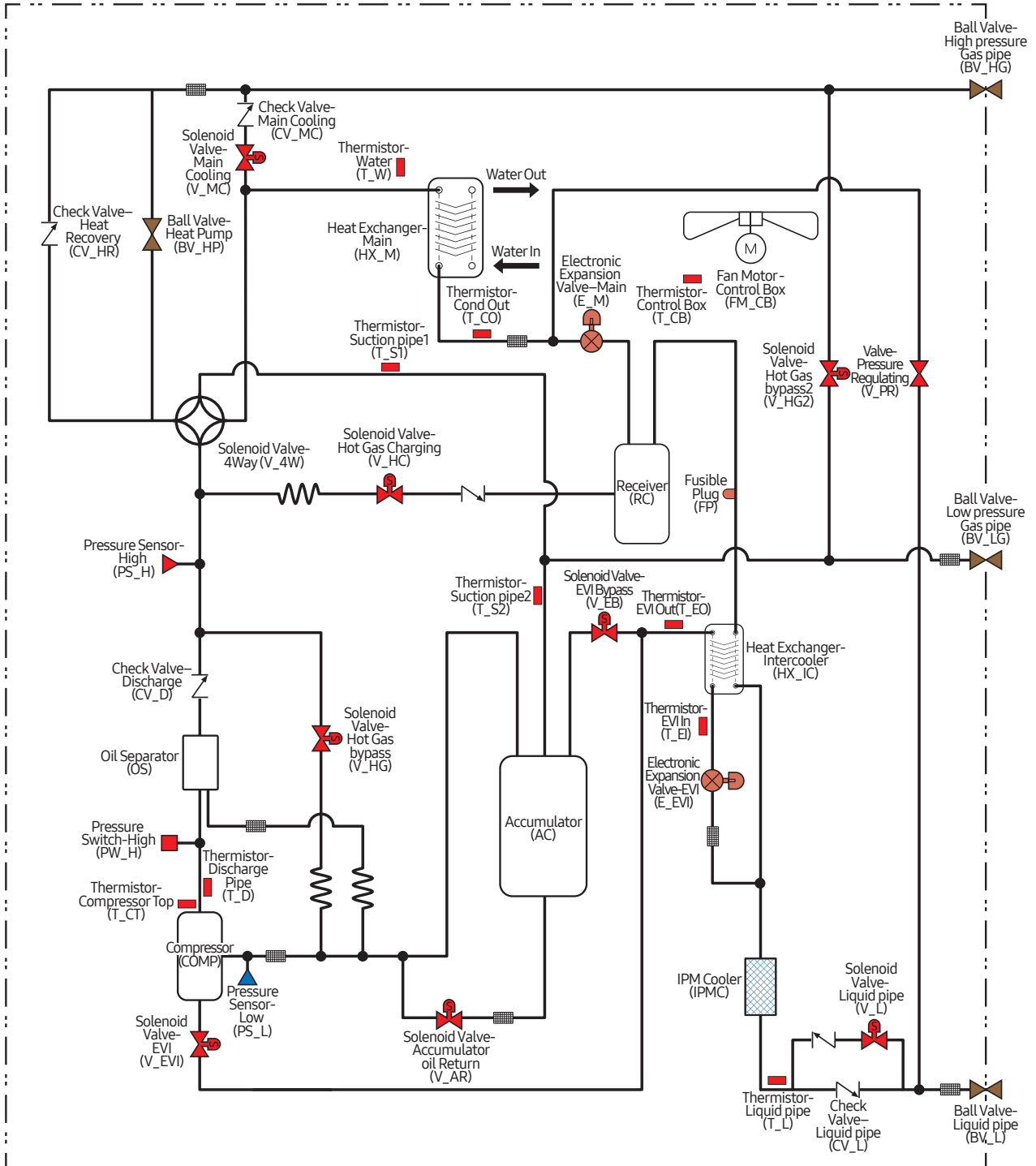

9. Piping Diagram

AM200MXWA**

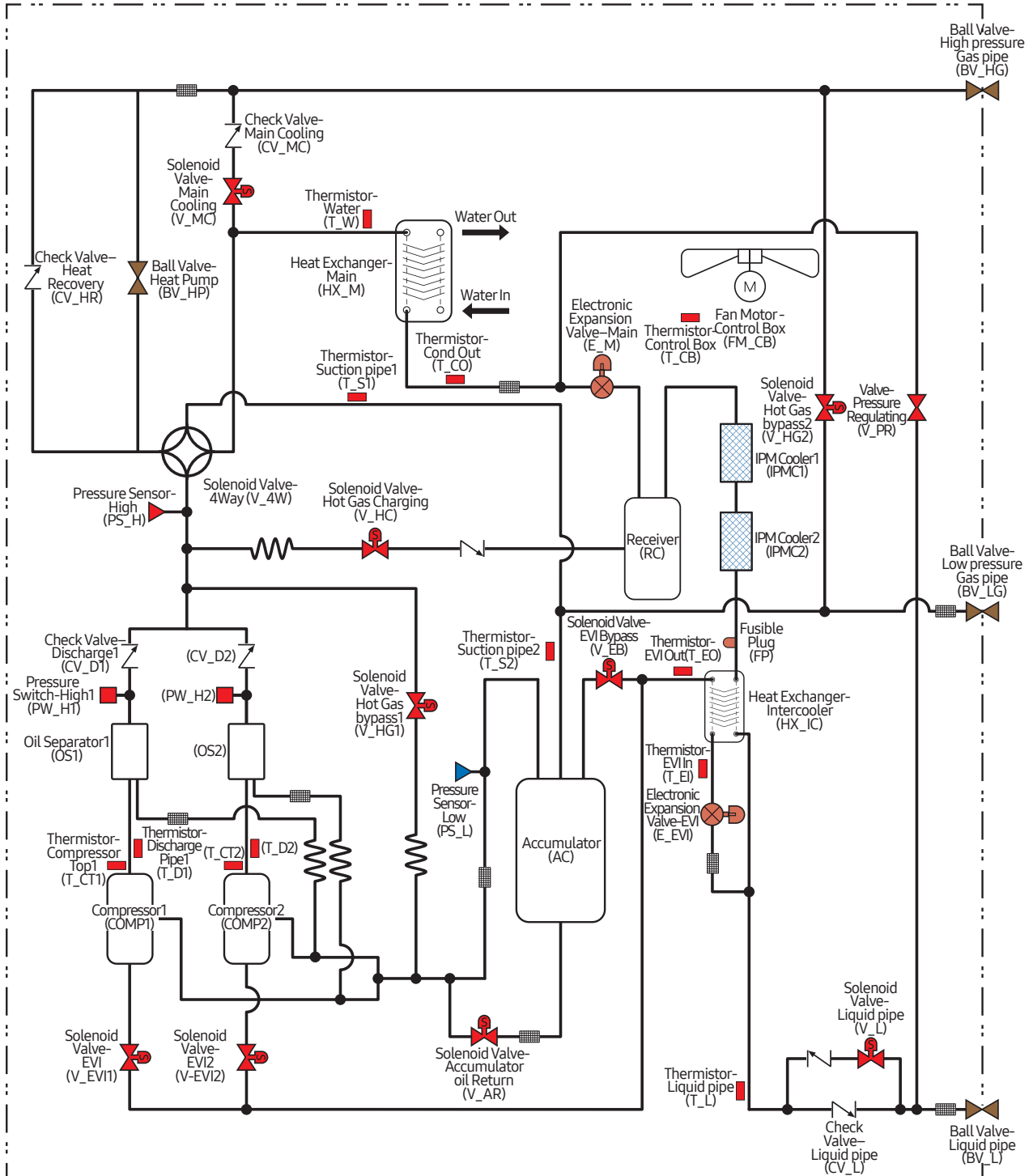

9. Piping Diagram

AM300KXWA**

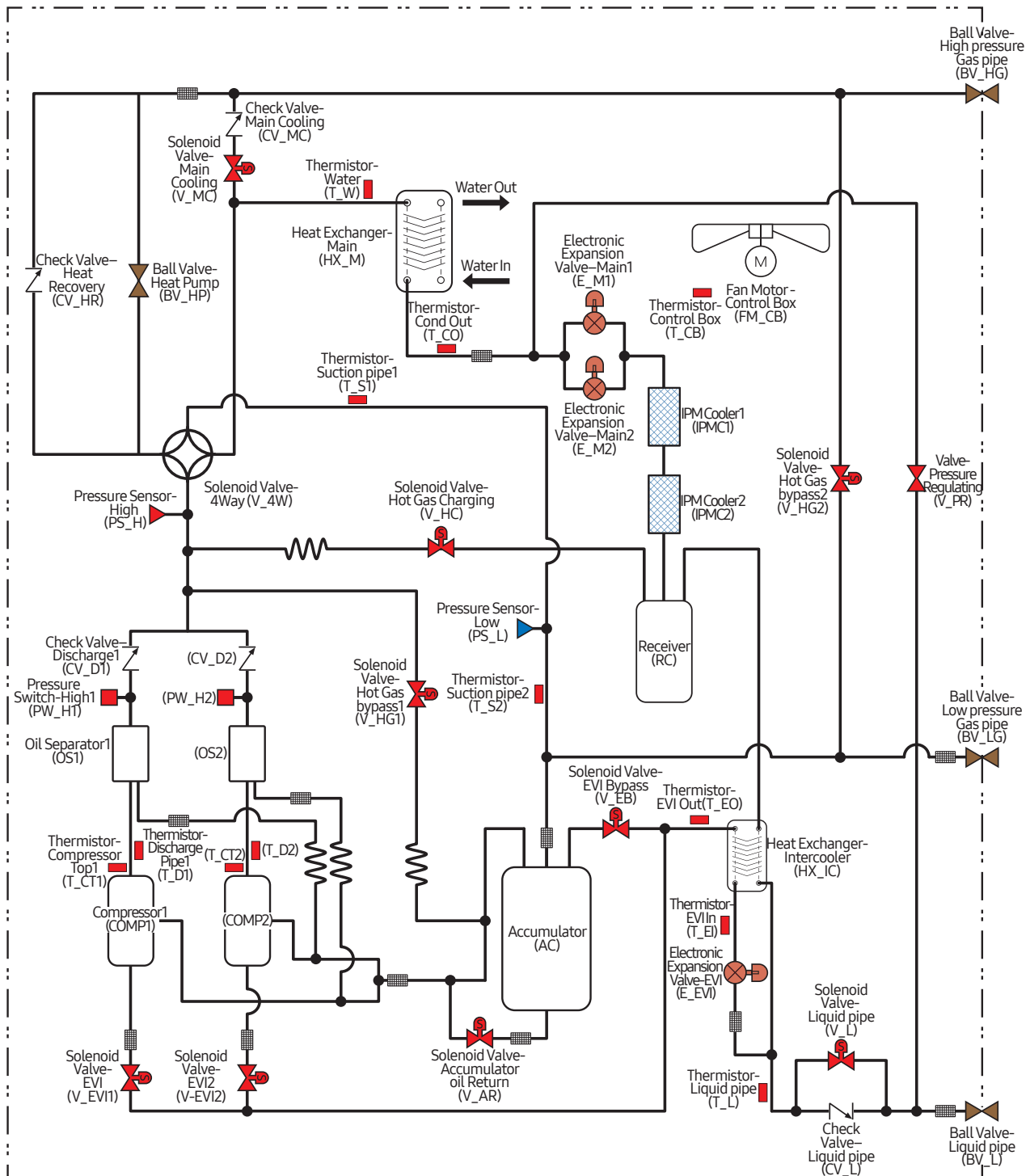

10. Installation

Electrical wiring work

Specification of the circuit breaker and power cable

Power Supply cords of parts of appliances for outdoor use shall not be lighter than polychloroprene sheathed flexible cord. (Code designation IEC:60245 IEC 66 / CENELEC: H07RN-F)

※ When installing outdoor units in module, select the power supply cable according to the sum of outdoor unit capacity. (Refer to the table for each model)

ex) Outdoor unit installation (AM100MXW× + AM120MXW×)

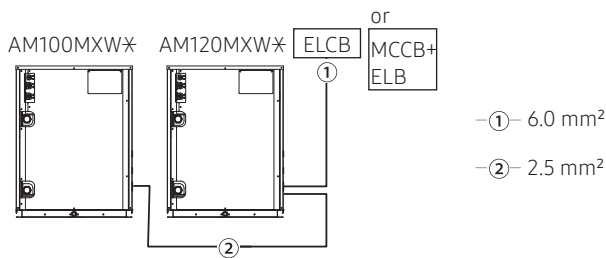

- This device is intended for the connection to a power supply system with a maximum permissible system impedance shown in the table (on the left page) at the interface point (power service box) of the user's supply.
- The user must ensure that this device is connected only to a power supply system which fulfills the requirement above. If necessary, the user can ask the public power supply company for the system impedance at the interface point.
- This equipment complies with IEC 61000-3-12 provided that the short-circuit power S_{sc} is greater than or equal to $S_{sc}(*2)$ at the interface point between the user's supply and the public system. It is the responsibility of the installer or user of the equipment to ensure, by consultation with the distribution network operator if necessary, that the equipment is connected only to a supply with a short-circuit power S_{sc} greater than or equal to $S_{sc}(*2)$.

[$S_{sc}(*2)$]

Model	S_{sc} [MVA]
AM080MXW×××	3.9
AM100MXW×××	3.9
AM120MXW×××	4.8
AM200MXW×××	7.7
AM300KXWA××	11.5

10. Installation



Caution for electrical work

- You must install ELCB or MCCB + ELB
 - ELCB: Earth leakage breaker
 - MCCB: Molded case circuit breaker
 - ELB: Earth leakage breaker
- Do not operate the outdoor unit before completing the refrigerant pipe work.
- Do not disconnect or change the cable inside the product. It may cause damage to the product.
- Specification of the power cable is selected based on following installation condition; culvert installation/ ambient temperature 30 °C/ single multi conductor cables. If the condition is different from the ones stated, please consult an electrical installation expert and re-select the power cable.
 - If the length of power cable exceed 50m, re-select the power cable considering the voltage drop.
- Use a power cable made out of incombustible material for the insulator (inner cover) and the sheath (outer cover).
- Do not use the power cable with the core wire exposed due to insulator damage occurred during removal of the sheath. When the core wire is exposed, it may cause fire.

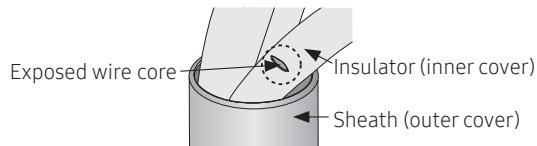

<The example of exposed core wire>

Power and communication cable configuration

- ▶ Main power and the ground cable must be withdrawn through the knock-out hole on the bottom-right or right side of the cabinet.
- ▶ Withdraw the communication cable from the designated knock-out hole on the bottom-right side of the front part.
- ▶ Install the power and communication cable using separate cable protection tube.
- ▶ Fix a protection tube to the knock-out hole on the outdoor unit by using a CD connector or bushing. Make sure to use insulating bushing.
- ▶ Make sure that power and communication cables do not block the front panel.

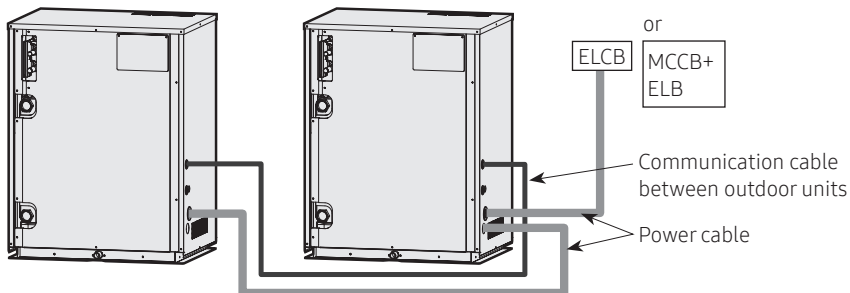

10. Installation

Specification of the protection tube

Name	Temper grade	Applicable conditions
Flexible PVC conduit	PVC	When the protection tube is installed indoor and not exposed to outside, because it is embedded in concrete structure
Class 1 flexible conduit	Galvanized steel sheet	When the protection tube is installed indoor but exposed to outside so there are risk of damage to the protection tube
Class 2 flexible conduit	Galvanized steel sheet and Soft PVC compound	When the protection tube is installed outdoor and exposed to outside so there are risk of damage to the protection tube and extra waterproof is needed

CAUTION | Caution for perforating the knock-out hole

- Perforate a knock-out hole by punching it with a hammer.
- After perforating the knock-out hole, apply rust resisting paint around the hole.
- When you need to pass the cables through the knock-out hole, remove burrs on the hole and protection the cable with a protection tape or bushing etc.

Power wiring diagram

Supplying 3 phase 4 wires (380-415 V~)

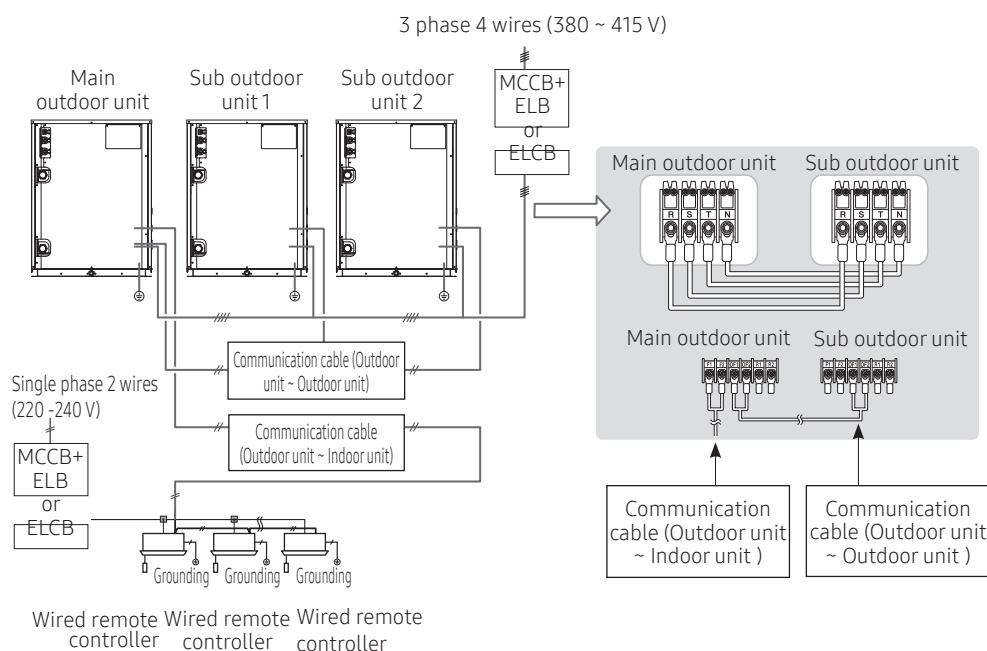

- ▶ Connect a power cable of the outdoor unit after checking that R-S-T-N (3 phase 4 wire) is properly connected. (If the 380-415 V power is supplied to the N phase, PCB and other electrical part will be damaged.)
- ▶ Communication cable between indoor and outdoor units and communication cable between outdoor units has no polarity.
- ▶ Arrange the cables with a cable tie.
- ※ ELCB and ELB must be installed since there is risk of electric shock or fire when they are not installed.

10. Installation

Connecting the power terminal

- ▶ Connect the cables to the terminal board with solderless ring terminals.
- ▶ Properly connect the cables by using certified and rated cables and make sure to fix them properly so that external force is not applied to the terminal.
- ▶ Use a driver and wrench that can apply the rated torque when tightening the screws on the terminal board.
- ▶ Tighten the terminal screws by complying rated torque value. If the terminal is loose, fire can occur due to arc heat generation and if the terminal is too tight, terminal board could get damaged.

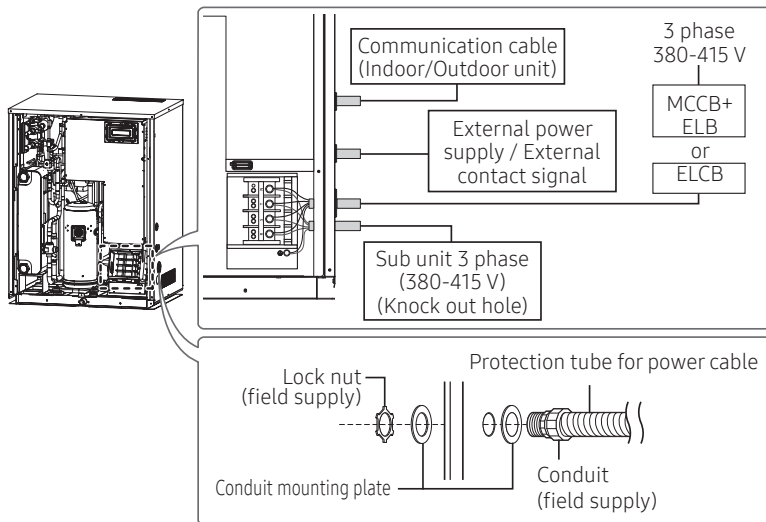

Screw	Tightening torque for terminal (N·m)	
M4	1.2~1.8	Single phase (220-240 V) power cable
M8	5.5~7.3	3 phase (380-415 V) power cable



- When removing the outer sheath of the power supply cable, be careful not to scratch the inner sheath of the cable.
- Make sure that more than 20mm of the outer sheath of the indoor unit power and communication cable are inside the electrical component box.
- Install the communication cable separately from power cable and other communication cables.

10. Installation

Installing the Solution device

- ▶ When the number of indoor units installed with the outdoor unit is 16 or less

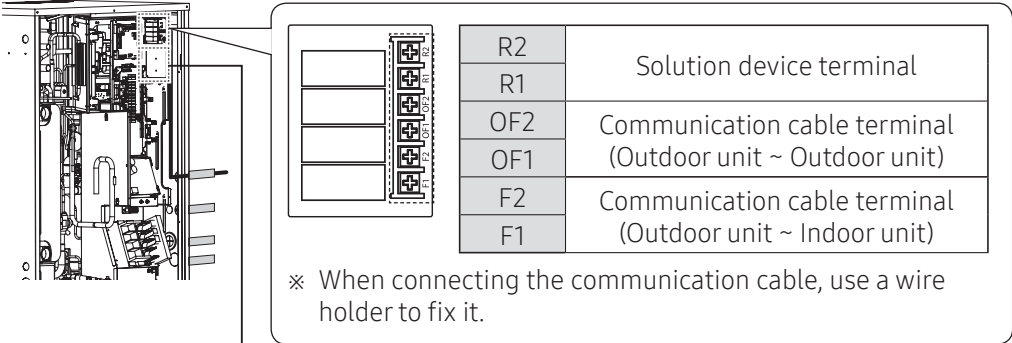

R2	Solution device terminal
R1	
OF2	Communication cable terminal (Outdoor unit ~ Outdoor unit)
OF1	
F2	Communication cable terminal (Outdoor unit ~ Indoor unit)
F1	

※ When connecting the communication cable, use a wire holder to fix it.

▶ Location of the interface module

※ To connect old communication type upper level controller, interface module must be installed. For detail instruction of installation, refer to the installation manual of corresponding interface module.

Space requirement for installation

Minimum space requirement for installation

- ▶ Secure minimum installation space as shown in the following figures, considering service area and path for people etc.
 - If the installation space is narrow, installer or other worker may get injured during work and may also cause problem to the product.
- ▶ If the conditions does not meet the space requirement in this manual, please contact qualified installation agent.

Single installation

When the water pipe passes through top of the product

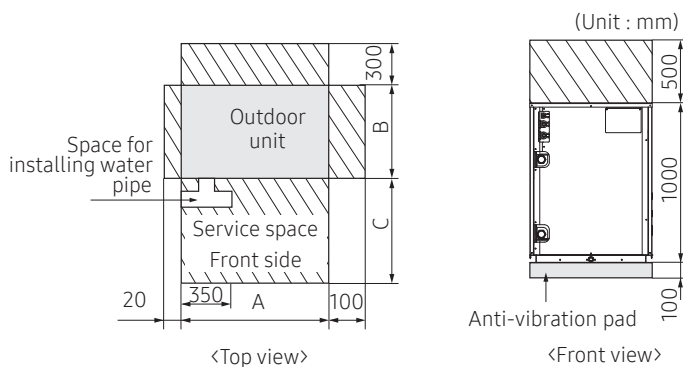

10. Installation

When the water pipe passes through back of the product

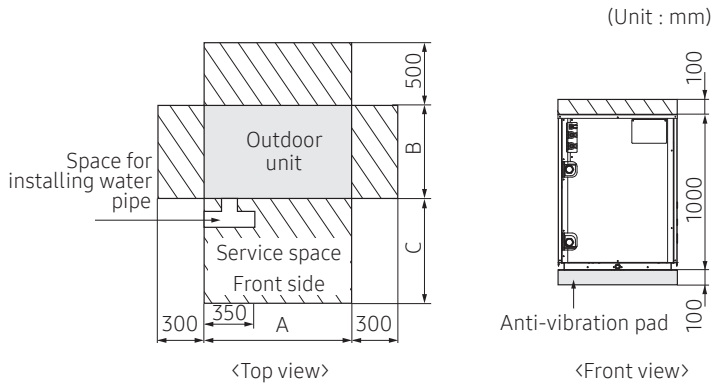

Module or continuous installation

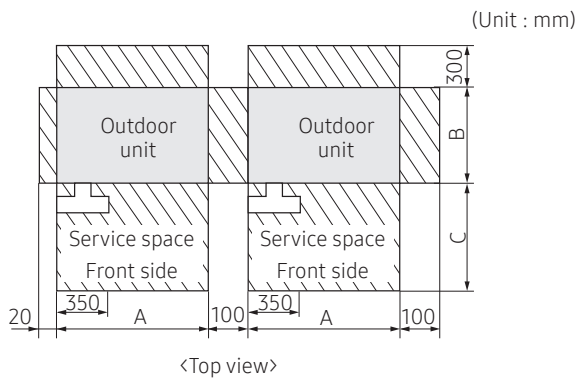

Model name of outdoor unit	A	B	C
AM080/100/120MXWA**	770	545	600
AM200MXWA** / AM300KXWA**	1100	545	600



- If the outdoor unit is needed to be installed close to the walls unavoidably, prevent the vibration from being transferred to the walls with cushioning materials etc.

10. Installation

Double installation

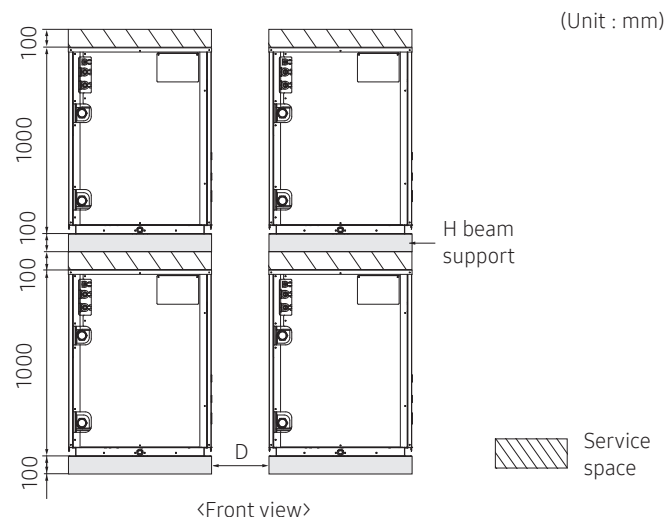

- ▶ For the double installation, service space is required for the front, rear, and sides of the product. For the size of the service space, refer to the service space size of single, module or continuous installation.
- ▶ Clear enough space for D (space between outdoor units), so that water pipes connected to outdoor units does not block the front side of the outdoor units next to it.

Base construction and installation of the outdoor unit



- Make sure to remove the wooden pallet before installing the outdoor unit. If you do not remove the wooden pallet, there is risk of fire during welding the pipes. If the outdoor unit is installed with wooden pallet on, and it was used for long period time, wooden palette may break and cause electrical hazard or high pressure may damage the pipes.

- ※ Fix an outdoor unit firmly on the base ground with anchor bolts.
 - ※ Manufacturer is not responsible for the damage occurred by not following the installation standards.
1. Make sure that the height of the base ground is 150 mm or higher to protect the outdoor unit from rain water or other external conditions. Also, install a draining pit around the base ground and connect the drain pipe to the drainage.
 2. Considering the vibration and weight of the outdoor unit, strength of the base ground must be strong to prevent noise and the top surface of it should be flat.
 3. Base ground should be 1.5 times larger than the bottom of the outdoor unit.
 4. Outdoor unit must be fixed firmly so that it can withstand the wind speed of 30 m/s. If you cannot fix the outdoor unit on the base ground, fix it by side or use extra structure.
 5. In heating operation, defrost water may form so you must really care about the drainage and waterproofing the floor. To prevent defrost water from stagnating or freezing, construct a drainage with over 1/50 slope. (Ice may form on the floor in winter time.)
 6. It is necessary to add wire mesh or steel bar during concrete construction for the base ground to prevent damages or cracks.

10. Installation

7. When installing multiple outdoor units at the same place, construct a H beam or an anti-vibration frame on the base ground to install the outdoor unit.
8. After installing a H beam or an anti-vibration frame, apply corrosion protection and other necessary coating.
9. When concrete construction for outdoor unit installation is completed, install an anti-vibration pad (t=20 mm or more) or an anti-vibration frame to prevent vibration of the outdoor unit from transferring to the base ground.
10. Place the outdoor unit on a H beam or an anti-vibration frame and fix it with the bolt, nut and washer. (The bearing force has to be over 3.5 kN)

Foundation

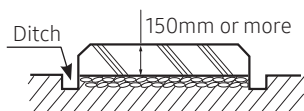

Outdoor unit installation

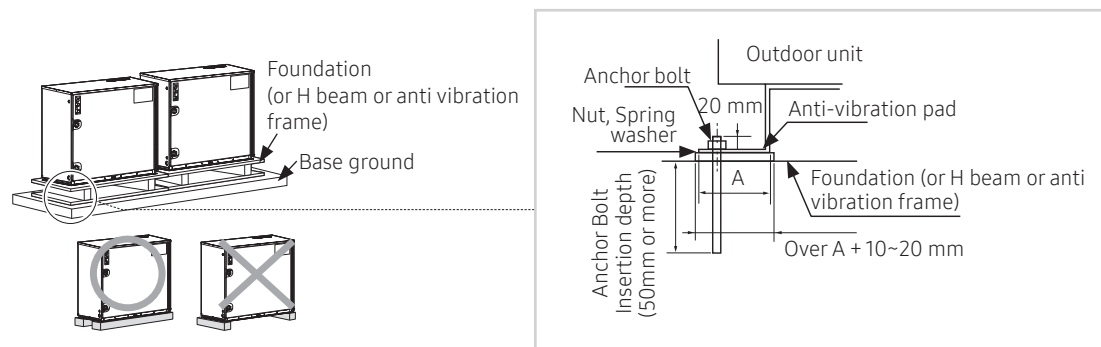

Fixing the outdoor unit

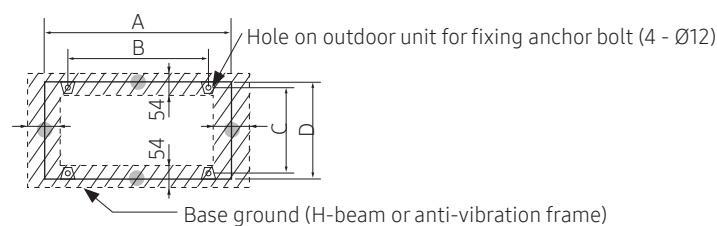

(Unit : mm)

Classification	Small type	Large type
Models	AM080/100/120MXWA**	AM200MXWA** / AM300KXWA**
A	770	1100
B	656	995
C	523	515
D	550	550

※ For adding the anti-vibration frame on the base ground, the specification for the fixing hole depends on the specification of the anti-vibration frame.

10. Installation

Refrigerant pipe installation



• When installing, make sure there is no leakage. When collecting the refrigerant, stop the compressor first before removing the connection pipe. If the refrigerant pipe is not properly connected and the compressor is working with the service valve open, the pipe sucks the air in which makes the pressure inside of the refrigerant cycle abnormally high which may lead to explosion and injury.

Refrigerant pipe work

- ▶ The length of refrigerant pipe should be as short as possible and the height difference between an indoor and outdoor unit should be minimized.
- ▶ Piping work must be done within allowable piping length, height difference, and the allowable length after branching.
- ▶ The pressure of the R-410A is high. Use only certified refrigerant pipe and follow the installation method.
- ▶ After installing the pipes, calculate the total length of the pipe to check if additional refrigerant is needed. When you need to charge the additional refrigerant, make sure to use R-410A refrigerant.
- ▶ The inside of the refrigerant pipe must be clean and contain no harmful ions, oxides, dust, iron particles or moisture.
- ▶ Use tools and accessories compatible with R-410A refrigerant gas.

Tool	Installation process/purpose	Compatibility with conventional tool	
Pipe cutter	Refrigerant pipe installation	Pipe cutting	Compatible
Flaring tool		Pipe flaring	
Refrigerant machine oil		Apply refrigerant oil on flared part	Exclusive ether oil, ester oil, alkali benzene oil or synthetic oil
Torque wrench		Connect flare nut with pipe	Compatible
Pipe bender		Pipe bending	
Nitrogen gas	Air tightness test	Prevent oxidation within the pipe	Compatible
Welder		Pipe welding	
Manifold gage	Air tightness test ~ additional refrigerant charging	Vacuuming, charging refrigerant and checking operation	Need exclusive one to prevent mixture of R-22 refrigerant oil use and also the measurement is not available due to high pressure
Refrigerant charging hose			Need exclusive one since there is risk of refrigerant leakage or contamination
Vacuum pump	Pipe drying		Compatible (Use products which contain the check valve to prevent the oil from flowing backward into the outdoor unit.) Use the one that can be vacuumed up to -100.7kpa(5Torr).
Scale for refrigerant charging			Compatible
Gas leak detector	Gas leak test		Need exclusive one (Ones used for R-134a is compatible)
Flare nut	Must use the flare nut supplied with the product. Refrigerant leakage may occur when the conventional flare nut for R-22 is used.		

10. Installation

Selecting refrigerant pipe

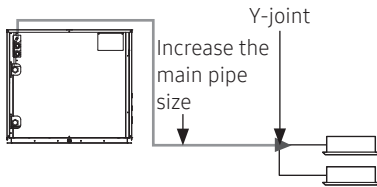

- ▶ Install the refrigerant pipe according to main pipe size of each outdoor unit capacity.
- ▶ When the pipe length (including elbow) between the outdoor unit and the farthest indoor unit exceeds 90m, the size of the pipe (main pipe) connecting the outdoor unit to the first branch joint must be increased by one grade.
- ▶ For HR System, when the pipe length (including elbow) between an outdoor unit and the farthest indoor unit exceeds 90 m, you must increase the size of the liquid pipe by one grade among the pipes(main pipe) which connects between the outdoor unit to the first branch joint

Main pipe size (Outer diameter, mm) If total pipe length is less than 90 m	Main pipe size (Outer diameter, mm) If total pipe length is 90 m or longer
9.52	12.70
12.70	15.88
15.88	19.05
19.05	22.22
22.22	25.40 ^{note1)}
28.58	31.75 ^{note2)}
34.92	38.10 ^{note3)}
41.28	53.98

Note1) If Ø 25.40 pipe is not available on site, use Ø 28.58 pipe.

Note2) If Ø 31.75 pipe is not available on site, use Ø 34.92 pipe.

Note3) If Ø 38.10 pipe is not available on site, use Ø 41.28 pipe

10. Installation

Pipe installation for an outdoor unit

1. Please read the following instructions to connect the refrigerant pipe to an outdoor unit.
 - For H/P System, connect liquid and gas pipes to an indoor unit.
 - For HR System, connect liquid and high/low pressure gas pipes to a MCU. Close the internal heat pump valve and set the following option switch.
 - For module installation, make sure that each heat pump valve and K5 switch setting is adjusted according to each purpose. (When installing outdoor units in module, E573 error may occur when settings are different between outdoor units.)

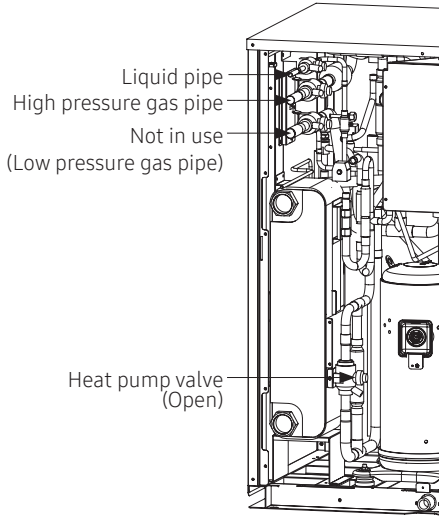
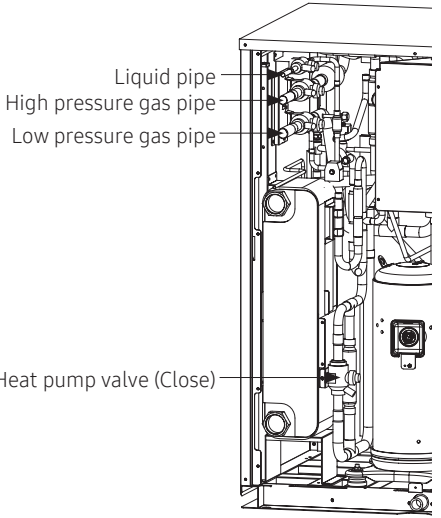
Classification		H/P System	HR System
Service valve		 <p>Liquid pipe High pressure gas pipe Not in use (Low pressure gas pipe) Heat pump valve (Open)</p>	 <p>Liquid pipe High pressure gas pipe Low pressure gas pipe Heat pump valve (Close)</p>
Heat pump valve		Open (Factory default)	Close (Set during installation)
Option switch	A Type PBA (K5)	ON (Factory default)	OFF (Set during installation)
	B Type PBA Key mode (K1+K2)	Set as "ht 00" (Factory default)	Set as "ht 01" (Set during installation)

※ Refer to the outdoor unit key function option switch and key function.



Caution for welding the pipe to an outdoor unit

- When welding the pipe, the unit may get damaged by the heat and flame from welding. Use a flame proofing cloth to protect the unit from a brazing fire or flame.
- The O-ring and Teflon packing inside service valve may get damaged by the heat from welding. Wrap the bottom side of the service valve with a wet cloth and weld it. Also, water dripping from the wet cloth may interrupt the welding. Make sure the water does not drip from the wet cloth.
- Make sure that connected pipes does not interrupt each other or make contact with the product. If they contact each other or contact with the outdoor unit, vibration will occur and it may cause damage to the pipes.
- When removing the sealed pipe on the bottom side of the service valve, cut it with a pipe cutter first and then start the welding. When the sealed pipe is welded without cutting, you may get injured by the refrigerant within the pipe.

10. Installation

Refrigerant pipe installation

2. Connect refrigerant pipes between outdoor units.

▶ To connect pipes between outdoor units, branch joints (that needs to be purchased separate) must be installed.

※ For optimal distribution of the refrigerant, you must use Y-joint for connecting outdoor units. (Do not use T-joint)

▶ When outdoor units are installed in module, there are no restrictions on the order of installation.

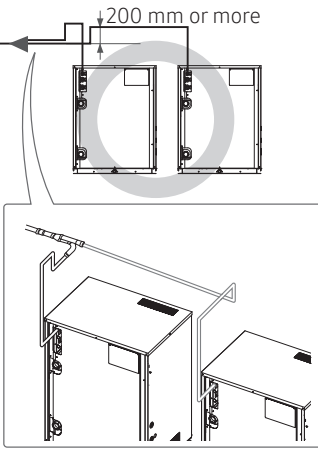
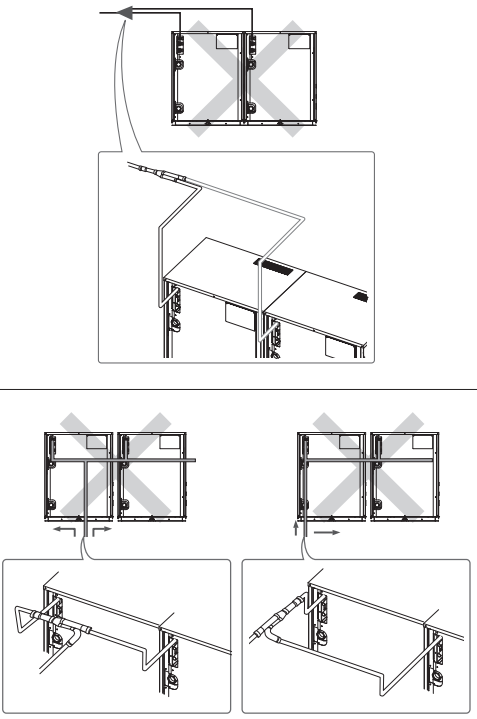
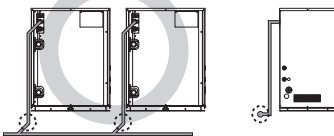
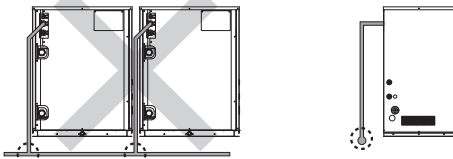
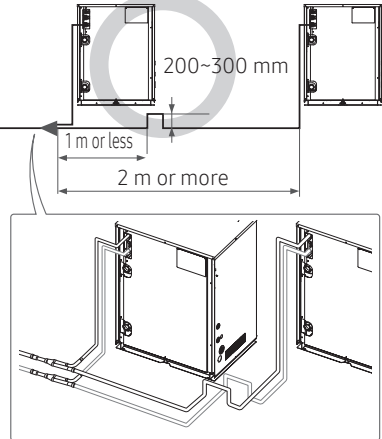
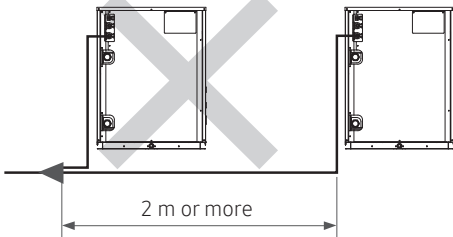
Caution	Correct installation	Incorrect installation
<p>When refrigerant pipe is installed at higher level than the pipe connection part of the outdoor unit, you must install a trap at the gas pipe.</p>		
<p>Branch joint between outdoor units must be installed horizontally.</p>		
<p>When the piping length between outdoor unit and the branch joint exceeds 2 m, install a vertical trap as show in the figure.</p>		

10. Installation

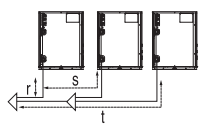
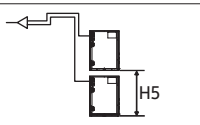
Classification				Example		Remarks
Maximum allowable pipe length	Outdoor unit ~ Indoor unit	Actual pipe length (Equivalent length)	170 m and below (190 m and below)	Installing only with Y-joint	$a+b+c+d+e+f+g+p \leq 170$ (190) m	Equivalent length • Y-joint: 0.5 m • Distribution header: 1 m
				Installing with Y-joint and distribution header	$a+b+h \leq 170$ (190) m, $a+i+k \leq 170$ (190) m	
				Installing only with distribution header	$a+i \leq 170$ (190) m	
	Total length of pipe (m)	500 m or less	Installing only with Y-joint	$a+b+c+d+e+f+g+p+h+i+j+k+l+m+n \leq 500$ m		
			Installing with Y-joint and distribution header	$a+b+c+d+e+f+g+h+i+j+k \leq 500$ m		
			Installing only with distribution header	$a+b+c+d+e+f+g+h+i \leq 500$ m		
Outdoor unit ~ Outdoor unit (Module installation)	Pipe length	10 m or less	$r \leq 10$ m, $s \leq 10$ m, $t \leq 10$ m			
	Equivalent length	13 m or less	$r \leq 13$ m, $s \leq 13$ m, $t \leq 13$ m			
	High difference	1.5 m or less	$H5 \leq 1.5$ m			
Maximum allowable height difference	Outdoor unit ~ Indoor unit	50/40 m <small>Note 2)</small>		$H1 \leq 50/40$ m		
	Indoor unit ~ Indoor unit	50 m or less		$H2 \leq 50$ m		
Maximum allowable length after branch joint	First branch joint ~ Farthest Indoor unit	Pipe length	45 m or less	$b+c+d+e+f+g+p \leq 45$ m, $i \leq 45$ m		
			45 m ~ 90 m <small>note 1)</small>	Required conditions must be satisfied		
EEV kit		Model name			Remarks	
EEV kit ~ Indoor unit	Actual pipe length	2 m	MEV-E24SA	1 indoor	Apply to products without EEV (Wall mount & ceiling)	
			MEV-E32SA			
		20 m or less	MXD-E24K132A	2 indoor		
			MXD-E24K200A			
			MXD-E32K200A			
			MXD-E24K232A	3 indoor		
			MXD-E24K300A			
			MXD-E32K224A			
MXD-E32K300A						

※ Please refer to the EEV Kit manual.

10. Installation

Note 1) Required condition

Classification	Condition	Example
First branch joint ~ Farthest Indoor unit	$45 \text{ m} \leq b+c+d+e+f+g+p \leq 90 \text{ m}$: Size of the branch pipe (b, c, d, e, f, g) must be increased by one grade	
Total length of extended pipe	If the size of the main pipe (pipe that connects between the outdoor unit ~ first branch joint) was not increased by one grade: $a+(b+c+d+e+f+g) \times 2 + h+i+j+k+l+m+n+p \leq 500 \text{ m}$	
	If the size of the main pipe (pipe that connects between the outdoor unit ~ first branch joint) was increased by one grade: $(a+b+c+d+e+f+g) \times 2 + h+i+j+k+l+m+n+p \leq 500 \text{ m}$	
Each Y-joint ~ Each indoor unit	$h, i, j, \dots, p \leq 45 \text{ m}$	
Difference between the distance of the outdoor unit to the farthest indoor unit and nearest indoor unit $\leq 45 \text{ m}$	$(a+b+c+d+e+f+g+p)-(a+h) \leq 45 \text{ m}$	

Note 2) When indoor unit is located at higher level than outdoor unit, allowable height difference is 40m, but when the indoor unit is located at lower level than outdoor unit, allowable height difference is 50 m.

※ Total refrigerant amount of the system must be less than 100kg. If total refrigerant amount of system is over than 100kg, the system has to be divided into smaller system, each less than 100kg.

Installing the branch joint between outdoor units

Installation of outdoor joints

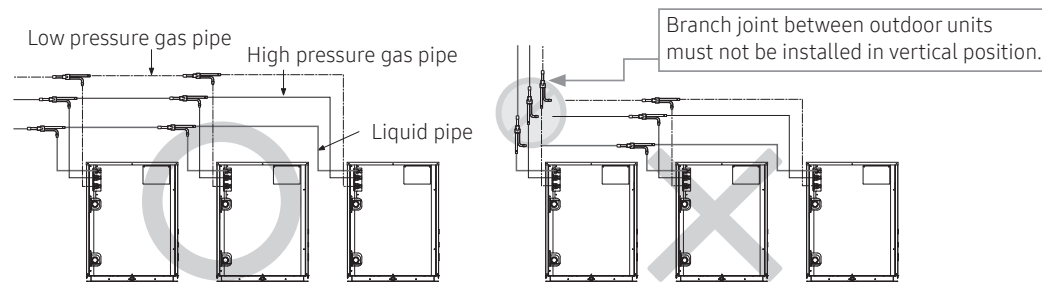

- ※ For HR System, connect liquid pipe, high pressure gas pipe and low pressure gas pipe.
- ※ For H/P System, connect liquid pipe and high pressure gas pipe.

10. Installation

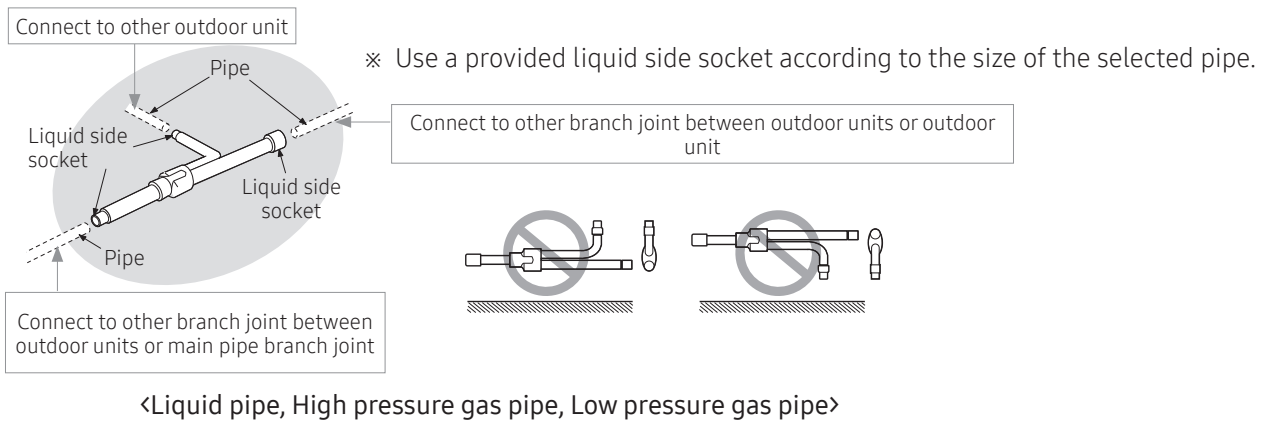

- Cut the connection part of the outdoor unit connection pipe or the provided socket, according to the diameter of the connection pipe, before connecting them.

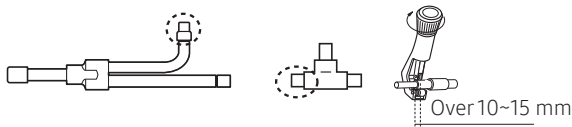

Installing the MCU

MCU specification

Model	MCU-S6NEK2N	MCU-S4NEK3N	MCU-S2NEK2N	MCU-S1NEK1N
Exterior of MCU				
Number of connectable indoor units at one port	Up to 8 units	Up to 8 units	Up to 8 units	Up to 8 units
The maximum capacity of the connectable indoor units at one port	16 kW	16 kW	16 kW	16 kW
The maximum capacity of the connectable indoor units	61.6 kW	61.6 kW	32.0 kW	16 kW
Internal EEV	Not included			

10. Installation

Installing the indoor units

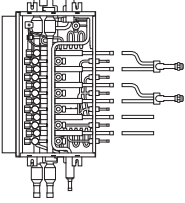
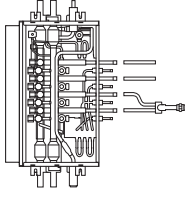
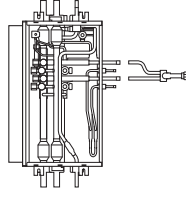
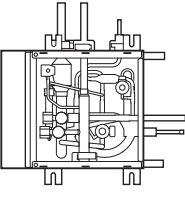
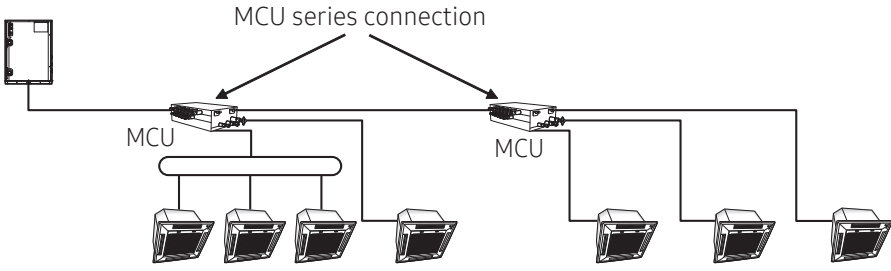
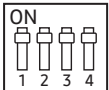
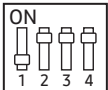
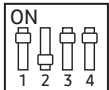
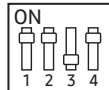
Model	MCU-S6NEK2N	MCU-S4NEK3N	MCU-S2NEK2N	MCU-S1NEK1N
Example installing (Each port connection)				
Example installing (MCU series connection)				
Installing indoor units	<p>Under 16.0 kW indoor unit : Don't use Y-connector 16.0 kW ~ 28.0 kW indoor unit : Use Y-connector at the Gas & Liquid line</p> <p>In case of using Y-connector, it is only connectable for port combination at below Connectable port combination for Y-connector : A + B port, C + D port, E + F port Non-connectable port combination for Y-connector : B + C port, D + E port, non-continuous port</p> <p>Set Dip Switch option for using Y-connector</p> <div style="display: flex; justify-content: space-around; align-items: flex-start;"> <div style="text-align: center;"> <p>S/W Option</p>  <p>Default</p> </div> <div style="text-align: center;"> <p>S/W Option</p>  <p>Combination of A+B port</p> </div> <div style="text-align: center;"> <p>S/W Option</p>  <p>Combination of C+D port</p> </div> <div style="text-align: center;"> <p>S/W Option</p>  <p>Combination of E+F port</p> </div> </div> <p>In case of MCU connection in series, the maximum capacity of indoor units in MCU series connection is 61.6 kW</p>			<p>This unit is only connectable for one port under 16 Kw</p> <p>This unit is impossible to connect MCU to MCU in series.</p>

10. Installation

How to connect the pipes

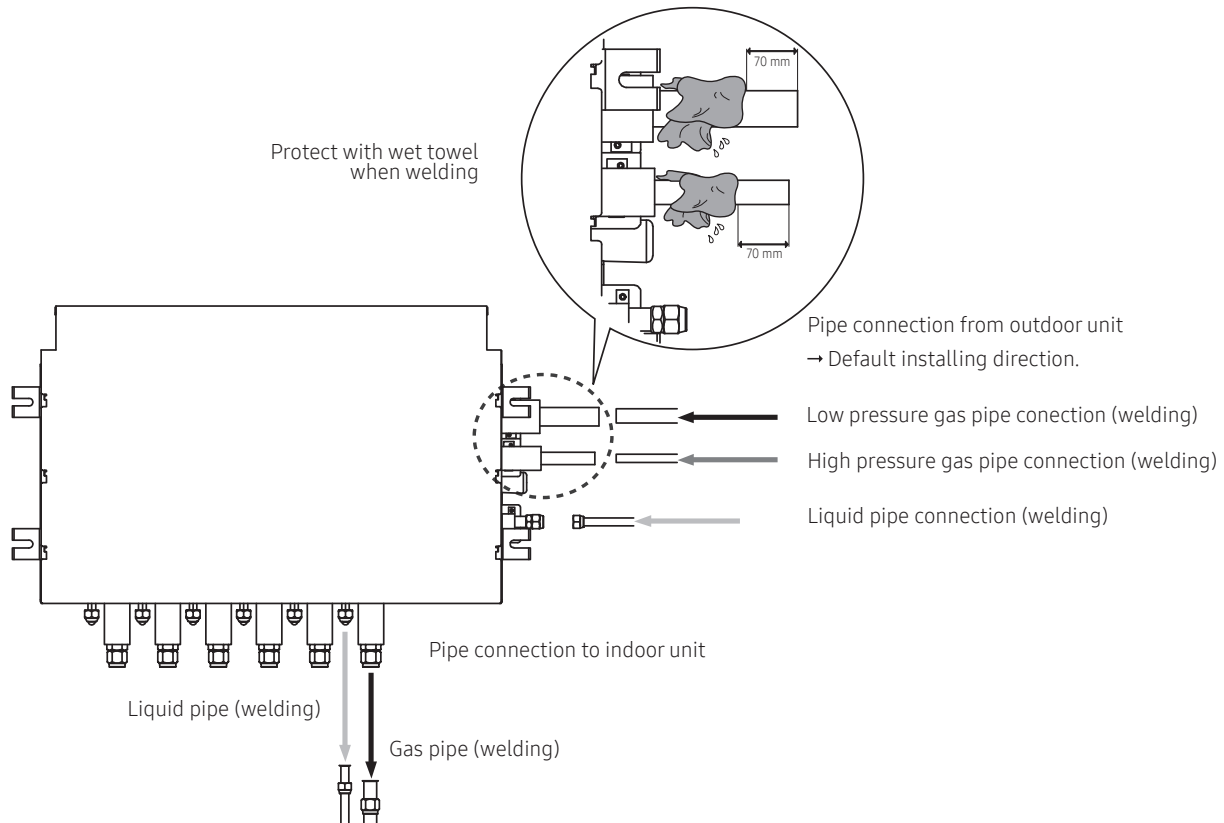

- ※ When installing MCU, use the pattern sheet for installation that is provided with the product.
- ※ When welding the gas pipes, protect the product with the flame-proof sheet.
- ※ When connecting the MCU with outdoor units, default direction is set in the MCU.
If installing opposite direction, weld the enclosed copper cap in each high pressure, low pressure and liquid pipes.

10. Installation

Water pipe installation

It is recommended to use closed circuit cooling tower. If open cooling tower is applied, use intermediate heat exchanger and make sure that supplied heat source water system is closed circuit.

Water pipe installation

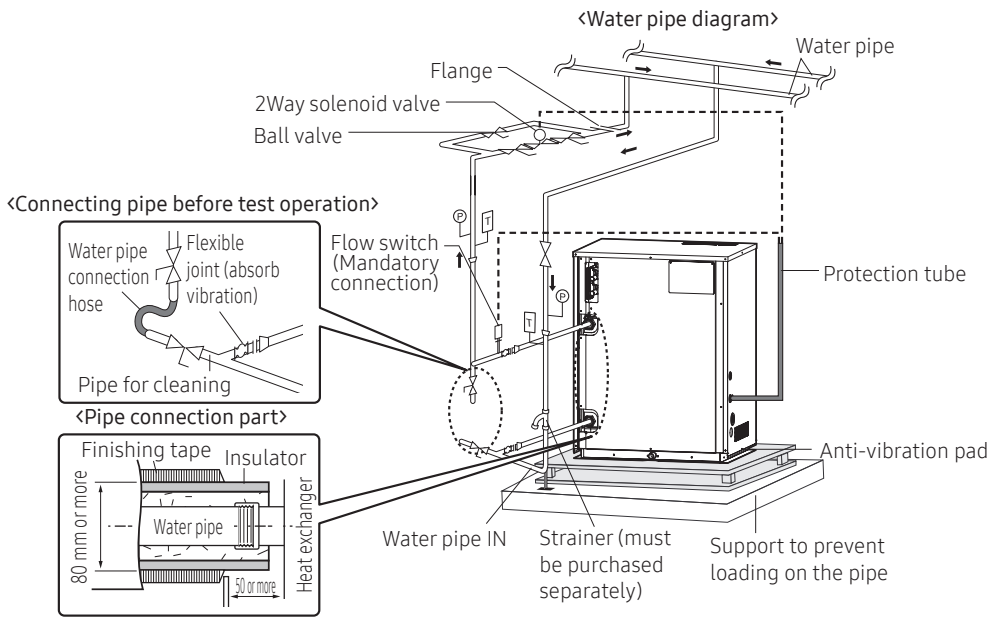

※ From above illustration, flow switch (mandatory) and 2way solenoid valve (optional) must be at least equivalent to the specification recommended by our company and they should be installed horizontally.



When water pipe circuit freezes, it will cause damage to the plate type heat exchanger and therefore preventive measure must be taken according to the situation.

- Drain remaining water in the water pipe when it will not be used for long period of time
- Constantly operate the water pump to circulate the water within the water pipe
- Install self-regulating heat cable on the water pipes

※ Design condition

Type	Circulating water	Operation	Inlet water temperature		Remarks
			Main usage range	Usage range limit ^{Note 3)}	
Heat source water	Water loop	Cooling	20 ~ 35 °C	10 ~ 45 °C	Refer to 'Cooling water management' on page 96
		Heating			
Ground heat source ^{Note 1)}	Ground loop	Cooling	15 ~ 35 °C	10 ~ 45 °C	
		Heating	5 ~ 25 °C	-5 ~ 45 °C (-10 ~ 45 °C) ^{Note 2)}	

Note 1): Anti-freeze must be used when temperature of water inlet for heating is below 10°C or ground heat source is used. Maintain appropriate concentration level of anti-freeze according to temperature of water inlet.

Note 2): Strict management of anti-freeze concentration level is required. Consult Samsung before application.

Note 3): When inlet water temperature is outside of limit, consult Samsung before application.

10. Installation

1. Diameter of the outdoor unit connection part where water pipe will be connected is 32A. If you install outdoor units with different capacities, install a flow control valve to secure rated flow for each outdoor unit. Socket must be connected within below tightening torque. If the tightening torque exceeds below value, it may cause product breakage.

Outer diameter of water pipe (mm)	Tightening torque (N·m)
10 ~ 20	25
21 ~ 30	50
31 ~ 50	100
51 ~ 80	220
81 ~ 115	600

2. Use certified parts for water pipe system and the water pressure of the water pipe system connected to outdoor unit must remain under 1.96 MPa.
3. Outdoor unit water pipes must be equipped with valves and other instrumentations as shown in the figure on the previous page. Strainer and flow switch must be installed within 1~2 m from the entrance pipe of the outdoor unit. (Strainer must be installed on entrance side)
 - When strainer is not installed, sand, dust or rust debris may cause product breakage.
 - Make sure to install a flow switch that works at minimum discharge. When optimal discharge level is not reached, heat exchanger within the outdoor unit may break.
4. Water inlet pipe is located at the bottom part of the heat exchanger and the water outlet pipe is at the top part of the heat exchanger.
5. Outdoor unit must be installed indoor at room temperature and the water inlet and outlet of the outdoor unit must be insulated with the heat exchanger as shown in the illustration.
6. Damp-proof, cold reserving and insulation work must be done thoroughly to prevent condensation from forming on the surface of the product and drain pipes of indoor/outdoor units. When the necessary work is not done thoroughly, you will waste energy caused by thermal loss and may get property damage during cold seasons when water pipe freezes and bursts.
7. If you stop the product for long time or in night time, water pipe circuit may freeze naturally when the temperature around the outdoor unit is under 0°C. When water pipe circuit freezes, it will cause damage to the plate type heat exchanger and therefore preventive measure must be taken according to the situation.
 - Drain remaining water in the water pipe
 - Operate continuous water circulation pump during outdoor unit operation, 1~5 minutes before the operation and 1~5 minutes after operation stops
 - Install self-regulating heat cable on the water pipes
8. When inlet water temperature is lower than 10°C, appropriate anti-freeze must be used according to the temperature. (Set the outdoor unit option switches K21 and K22 according to the usage temperature.)
 - When lowest inlet water temperature is -5°C, freezing point of anti-freeze must be lower than -8°C
 - When lowest inlet water temperature is -10°C, freezing point of anti-freeze must be lower than -15°C
9. Install number of auto air vent valve at a point where air may remain within the pipe (such as vertical water pipe). If the air within the pipe is not vented, it may cause performance decrease or corrosion on the product or pipes.
10. Keep the inlet water temperature within 'Main usage range'. If not, product may not work continuously.
11. Water scale may occur on the plate type heat exchanger depending on the water quality and the type of plate heat exchanger so regular chemical cleaning is necessary. When installing water pipes, install a heat source water shut-off valve and also install the flushing pipe with a ball valves (for chemical cleaning) on the pipe installed between the shut-off valve and the outdoor unit.

10. Installation

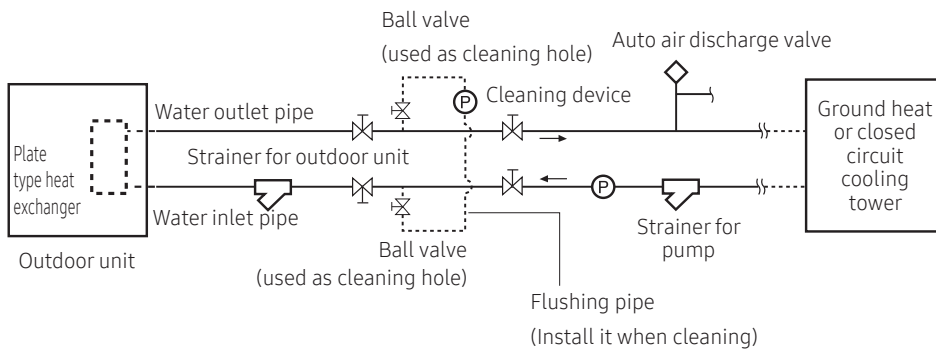

12. Before trial operation, connect the cleaning pipes installed on inlet and outlet as shown in above illustration. Then, take appropriate measures (such as blind flange etc) to stop the circulation water from entering the outdoor unit plate type heat exchanger, and use circulating pump to remove foreign substance within the water pipes and clean the strainer. When foreign substances accumulates on outdoor unit plate type heat exchanger, it may break the heat exchanger or cause problem to it.
13. For legal facilities, install digital sensor and flow meter on the water pipe for monitoring.



- Open the valve of the water pipe connected to the outdoor unit after flushing (cleaning foreign substances in water pipe) is completed.
- Check that air is vented from the water pipe and circulation amount is secured before opening the service valve on the refrigerant side of the outdoor unit.
- When circulating water stops during outdoor unit operation, it may cause breakage on plate type heat exchanger. Check the flow of circulation with flow switch or other devices.

2021.02
Ver.1.2

Samsung Electronics Co., LTD.

Head Office (Suwon Korea) 129, Samsung-Ro, Yeongtong-Gu, Suwon City, Gyeonggi-Do, Korea 16677
Website : www.samsung.com, <https://partnerhub.samsung.com> Email : airconditioner@samsung.com
Images and data in this book may subject to change without prior notice.